

Digital Drum

Owner's Manual

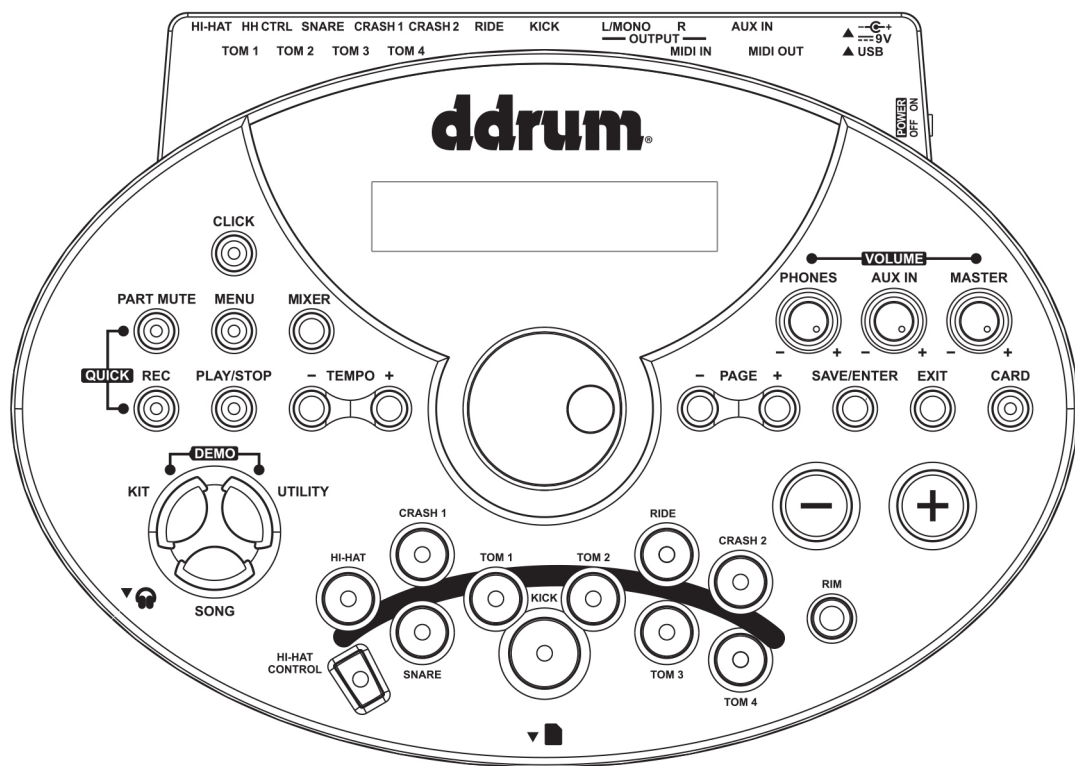

ddrum®

DD5X

GENERAL
MIDI

INFORMATION FOR YOUR SAFETY!

THE FCC REGULATION WARNING (for USA)

This equipment has been tested and found to comply with the limits for a Class B digital device, pursuant to Part 15 of the FCC Rules.

These limits are designed to provide reasonable protection against harmful interference in a residential installation. This equipment generates, uses, and can radiate radio frequency energy and, if not installed and used in accordance with the instructions, may cause harmful interference to radio communications. However, there is no guarantee that interference will not occur in a particular installation. If this equipment does cause harmful interference to radio or television reception, which can be determined by turning the equipment off and on, the user is encouraged to try to correct the interference by one or more of the following measures:

- Reorient or relocate the receiving antenna.
- Increase the separation between the equipment and receiver.
- Connect the equipment into an outlet on a circuit different from that to which the receiver is connected.
- Consult the dealer or an experienced radio/TV technician for help.

Unauthorized changes or modification to this system can void the user's authority to operate this equipment.

CAUTION

The normal function of the product may be disturbed by Strong Electro Magnetic Interference. If so, simply reset the product to resume normal operation by following the owner's manual. In case the function could not resume, please use the product in other location.

PRECAUTIONS

PLEASE READ CAREFULLY BEFORE PROCEEDING

Please keep this manual in a safe place for future reference.

Power Supply

Please connect the designated AC adaptor to an AC outlet of the correct voltage.

Do not connect it to an AC outlet of voltage other than that for which your instrument is intended.

Unplug the AC power adaptor when not using the instrument, or during electrical storms.

Connections

Before connecting the instrument to other devices, turn off the power to all units. This will help prevent malfunction and / or damage to other devices.

Location

Do not expose the instrument to the following conditions to avoid deformation, discoloration, or more serious damage:

- Direct sunlight
- Extreme temperature or humidity
- Excessive dusty or dirty location
- Strong vibrations or shocks
- Close to magnetic fields

Interference with other electrical devices

Radios and televisions placed nearby may experience reception interference. Operate this unit at a suitable distance from radios and televisions.

Cleaning

Clean only with a soft, dry cloth.

Do not use paint thinners, solvents, cleaning fluids, or chemical-impregnated wiping cloths.

Handling

Do not apply excessive force to the switches or controls.

Do not let paper, metallic, or other objects into the instrument. If this happens, unplug the AC adaptor from the wall outlet. Then have the instrument inspected by qualified service personnel.

Disconnect all cables before moving the instrument.

Contents

Panel & Display Description

Front Panel.....	4
Rear Panel.....	5
Display.....	5

Setup

Connect the Pads and the Pedals.....	6
--------------------------------------	---

Connections

Connect a MIDI and USB Device.....	7
Connect Audio Equipment.....	7
Connect a CD Player, etc. (Aux. In Jack).....	7
Connect Headphones.....	7
Connect the Power Supply Jack.....	7

Basic Operations

Adjust Value.....	8
Listening to the Demo Song.....	8
Choosing a Drum Kit.....	8
Play Song.....	9
Turning the Metronome (Click) On and Off.....	9

Advanced Use

Selecting a Drum Kit (KIT)

Selecting a Drum Kit.....	10
Selecting Pad.....	11
Drum Kit Setting.....	12
Selecting Voices.....	12
Selecting Pad Voice.....	12
Editing Voices Parameters.....	13
Playing a Song by Hitting a Pad (Pad Pattern).....	14
Exchange Kit Order.....	15
Rename Kit.....	15
Saving Kit.....	16

Using the Mixer (MIXER)

Master Volume.....	17
--------------------	----

Song Selection(SONG)

Song Choosing.....	18
Song Playing Back.....	19
Adjusting Song Acmp Volume.....	19
Temporarily Changing the Tempo.....	19
Song Editing.....	19
Song Setting.....	19
Part Settings (Drum/Perc/Part1~Part5).....	21
Drum/Perc Part.....	21
Erase a Song.....	22
Saving Song.....	22
Saving Song to Local.....	23
Saving Song to SD Card.....	23

Muting a Selected Part (PART MUTE)

Mute On.....	24
Mute Off.....	24
Setting Mute.....	24
Mute a Part of Song.....	24
Mute a Channel of the MIDI File.....	24

Record(RECORD)

Record a New Song.....	25
Quick Record.....	25
Record.....	25
Recording Based on Preset Song.....	26
Record Setting.....	27
The Error Information during Recording.....	28

Setting the Metronome (CLICK)

Click On/Off.....	29
Click Settings.....	29

Save Data(SAVE)

Saving User Kit.....	30
Saving User Song.....	30
Saving Global Setup.....	30

Pad and Trigger Setting(UTILITY).....31

Setting Effect (REVERB/EQ)

MIDI Settings.....	33
Factory Reset.....	34
Automatic Shutdown.....	34

SD Card Operation(CARD)

Search for Files in a SD Card.....	35
Playback MIDI files in a SD Card.....	35
Playback.....	35
Mute a Channel of the MIDI File.....	35
File Operations.....	36
Load.....	36
Delete.....	37
Loop.....	37
Format.....	38
The Error Information during a Card Operation.....	38

Making the Settings for MIDI

About MIDI.....	39
Connecting with an External Sound Device.....	39
Using the Digital Drum as a Sound Module.....	40

Appendices

Troubleshooting.....	41
Specification.....	42
Drum Kit List.....	43
Drum Voice List.....	44
Song List.....	48
Demo List.....	49
ASCII Character List.....	49
GM Drum Kit List.....	50
GM Backing Instrument List.....	53
MIDI Implementation Chart.....	55

BASIC OPERATIONS

ADVANCED USE

APPENDICES

Panel & Display Description

Front Panel

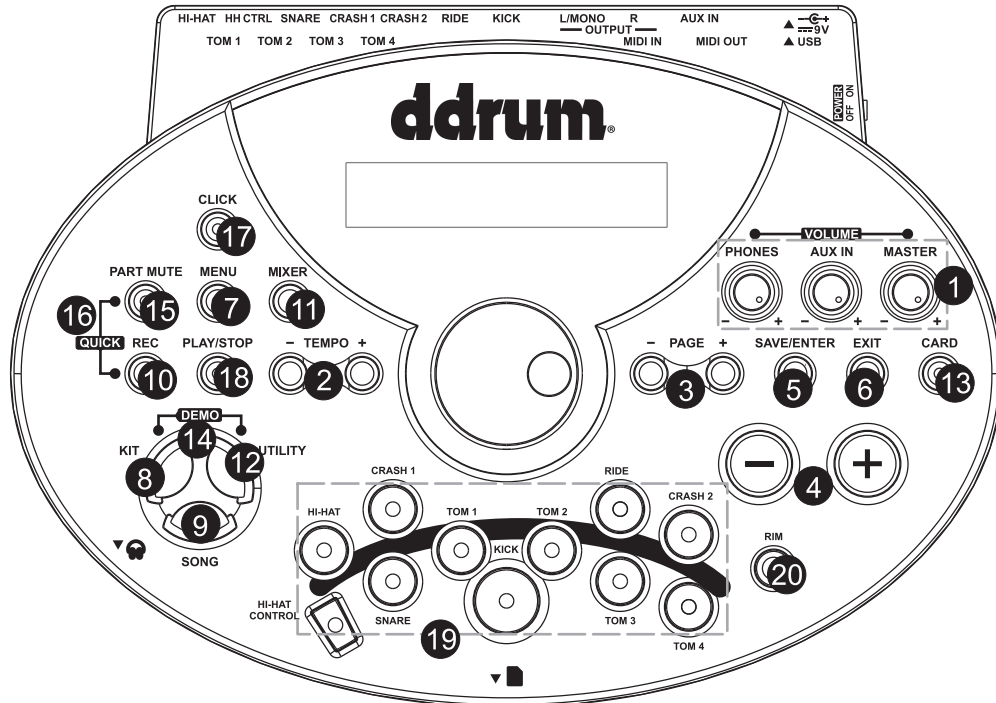

1. **[MASTER] / [AUX] / [PHONES] buttons**
Master Volume (control output Volume), Aux In volume, phone volume Knobs.
2. **[TEMPO+] / [TEMPO-] buttons**
Adjust current tempo of Song, Click, etc; Press [TEMPO+] and [TEMPO-] buttons simultaneously to reset to default tempo.
3. **[PAGE+] / [PAGE-] buttons**
Page Buttons, Scroll through the menu pages, or move the cursor left/right when naming.
4. **[+] / [-] buttons**
Increase or decrease the current parameter, or select the character when naming.
5. **[SAVE / ENTER] button**
Enter the Save menu when available, enter the current folder or confirm current operation.
6. **[EXIT] button**
Exit from the current sub-menu back to the superior level menu or exit the current folder back to parent folder.
7. **[MENU] button**
Enter current mode's menu to set parameter; Hold [MENU] button then press [PART MUTE] or [CLICK] buttons, would enter mute or click setting menu.
8. **[KIT] button**
Enter Kit Mode to select a Kit.
9. **[SONG] button**
Enter Song Mode to select a song.
10. **[REC] button**
Enter the Record menu.
11. **[MIXER] button**
Enter MIXER menu, adjust master volume including Kit volume, Song volume, Card MIDI song volume or Click volume.
12. **[UTILITY] button**
Adjust the parameters of global setup, such as sensitivity, curve, effect, MIDI setup, etc.
13. **[CARD] button**
Enter SD card mode, load, delete, play or format the SD card.
14. **[UTILITY] + [KIT] buttons**
Enter DEMO mode and start to play demo.
15. **[PART MUTE] button**
Part mute switch.
16. **[REC] + [PART MUTE] buttons**
Quick record for quickly recording drum part.
17. **[CLICK] button**
Click switch.
18. **[PLAY / STOP] button**
Control the play of a song or a Card MIDI song, or start/stop recording.
19. **Pad select buttons and indicators (11)**
These buttons can play the pad voices of the current kit. In KIT Menu /Mixer/UTILITY menu, they select the pad to be edited and the indicators show the current selected pad. In SONG/DEMO/ mode, the indicators will display which pads are being played by the drum track.
20. **[RIM] button**
Allows access to the second voice for dual-zone triggers (Snare, Hi-Hat, Tom, etc.).

Panel & Display Description

Rear Panel

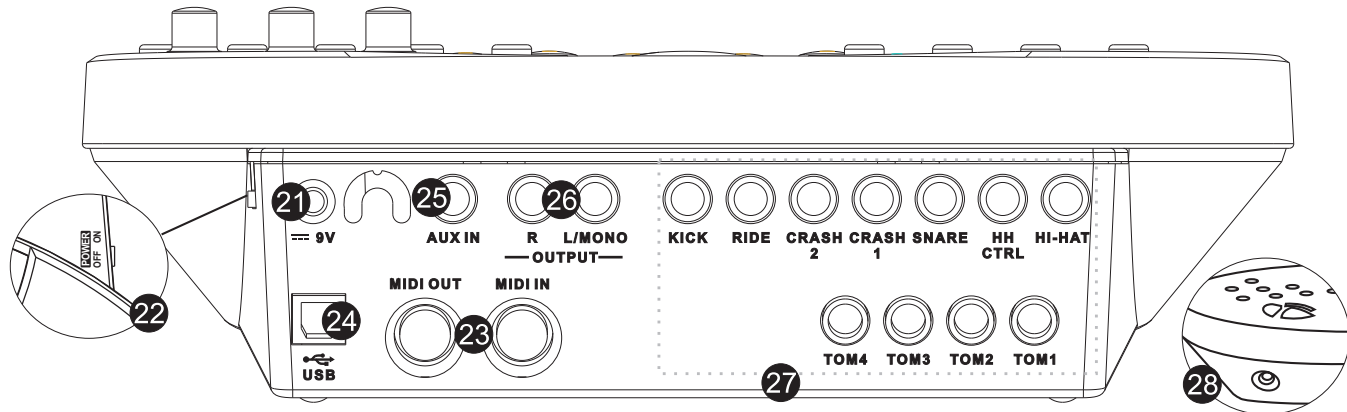

21. DC input

Connect for the DC 9V power adapter.

22. Power switch

This switch turns power on and off.

23. MIDI IN and MIDI OUT

These ports allow communication with other products equipped with a MIDI interface or other USB host devices with USB interface. Please see the MIDI section of the advanced manual for details.

24. USB port

This port is used to connect to a computer or a USB host device (MIDI In/Out via USB).

25. AUX IN

This stereo input jack is used for an external sound source such as an MP3 or CD player.

26. Line output jacks

Stereo output connection to an audio system or drum amplifier.

27. Pad input jacks

Input connections for Kick, Snare, Tom, Cymbal pads and Hi-Hat control pedal.

28. Phone jack

This stereo jack is used to connect headphones.

Display

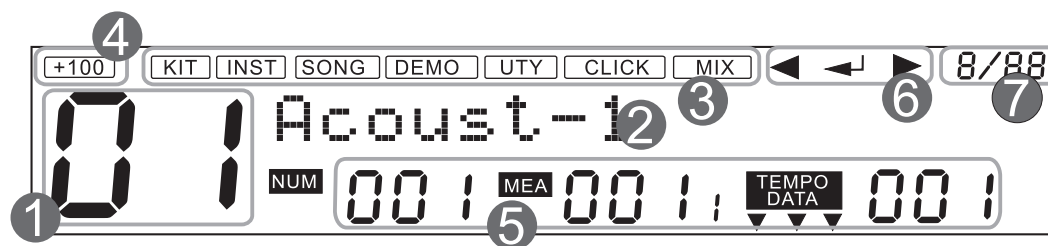

1. Current Kit index

2. Main Display

A dot matrix that allows displaying variable size fonts and icons. The main part of this dot matrix is used to display the current kit or song name, and all the various Menus.

3. Mode icon

The top line of the LCD display current mode icon. ("Kit" icon is always lightened)

4. Current Kit index

5. Song num, Measure, Beat, Tempo

(In menu pages, when selecting group, voice or pad pattern index, the icon "DATA" is lightened, indicates the current voice or song's index)

6. These icons indicate that the [PAGE-] / [SAVE/ENTER] / [PAGE+] is valid

7. The current time signature

Setup

Caution!

To prevent electric shock and damage to the device, make sure the power is switched OFF on the drum and all related device before making any connection.

Connect the Pads and the Pedals

Using the provided cables, connect each Trigger input jack on the rear panel of the module, and make sure each pad is connected to its corresponding Trigger input jack.

Note:

1. The voice of hi-hat pad hitting is controlled by hi-hat pedal. Similar to a real drum kit, the hi-hat pad functioned as an 'open hi-hat' when the pedal is released. When the pedal is stepped, it functions as a 'closed hi-hat'
2. The valid striking area of a cymbal pad (ride, crash or hi-hat) is near the edge of the pad, which is different from other pads.

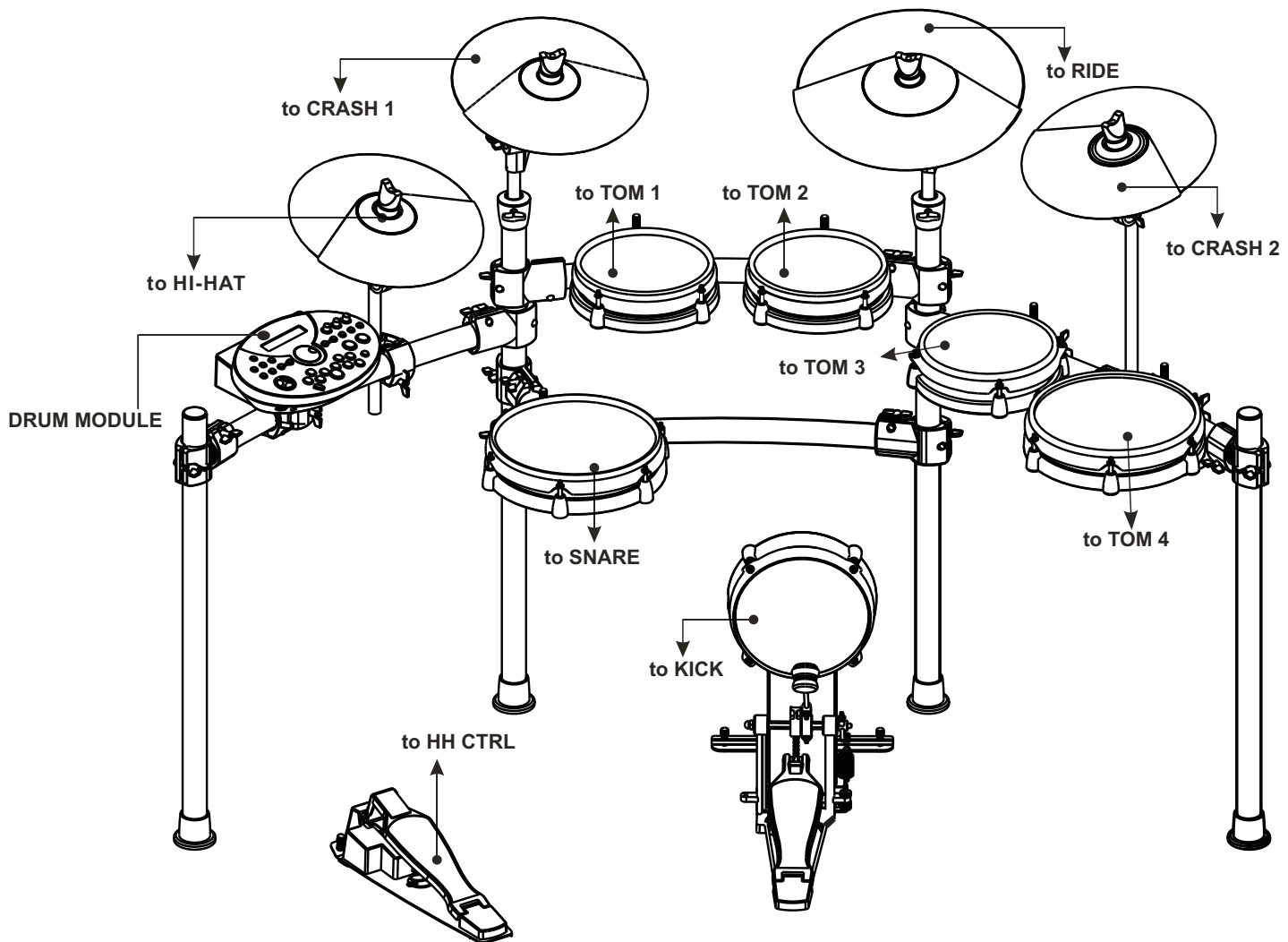

Connections

Connect a MIDI and USB Device

1. This is for you want to use an external sound module or MIDI sequencer.
2. The drum will output all the MIDI codes generated by hitting pads or stepping pedal via the MIDI output or USB port. But clicking and the MIDI codes in songs are excluded.
3. The USB Port is used only for MIDI messages.
4. MIDI clocks will be sent automatically after power-on.

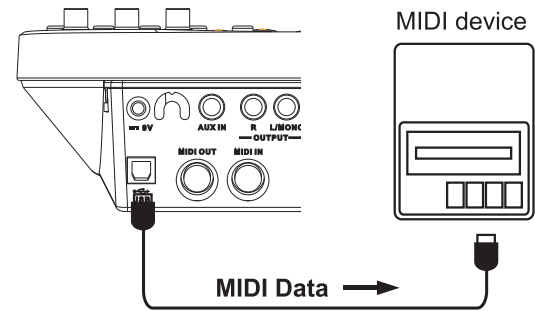

Connect Audio Equipment

1. When you want to listen to the voices with an amplifier, connect amplifiers with the Output L/MONO and R jacks on the rear panel. (For monaural playback, use the L/MONO jack, for stereo playback; connect both L/MONO and R jacks.)
2. The volume is adjusted with the MASTER VOLUME knob.

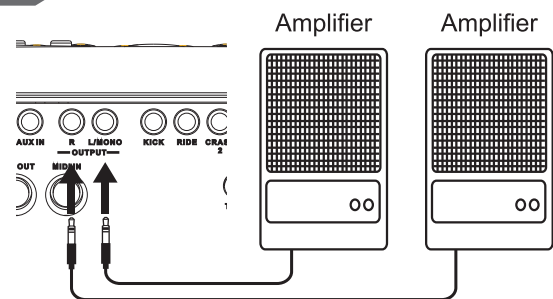

Connect a CD Player, etc. (Aux. In Jack)

1. The audio output of a CD player, or other audio source, to connect with the AUX IN jack on the rear panel can be mixed with the sound of the drum. This function is convenient that lets you play along with a favorite song.
2. The volume of the external signal is adjusted with the AUX IN VOLUME knob.

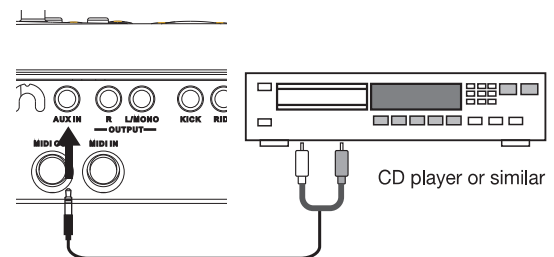

Connect Headphones

1. An optional set of stereo headphones can be connected with. The PHONES jack located on the side of the drum module.
2. Adjust the PHONES volume to a comfortable level.

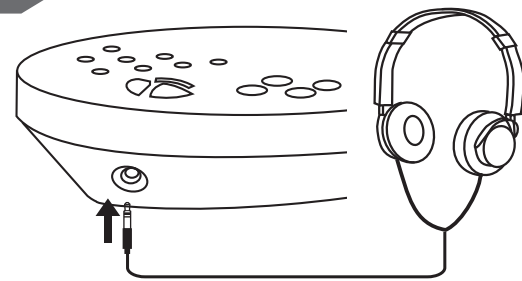

Connect the Power Supply Jack

Make sure the power is switched OFF and connect the power adaptor with the DC IN jack on the rear panel.

Note:

1. To protect the speakers, amplifier and the drum module from damage, rotate the volume knob to the minimum volume level before switching the power ON.
2. Make sure the power is switched OFF when connecting drum module with external devices.
3. In the IDLE mode, the drum module will automatically shutdown in 30 minutes later if you do not take any action on the drum module or hit pad. For more information, see the menu: Automatic Shutdown.

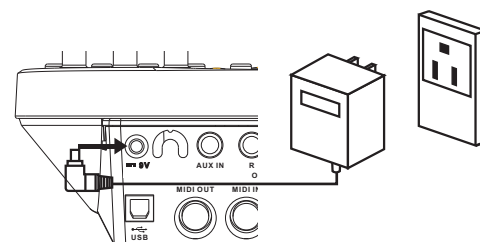

Basic Operations

Adjust Value

- Both the [+] / [-] button and DIAL are used to change the values of settings. If you hold on the [+] or [-] for a while the value will increase or decrease rapidly.
- The DIAL allows you to make major changes to the value quickly.

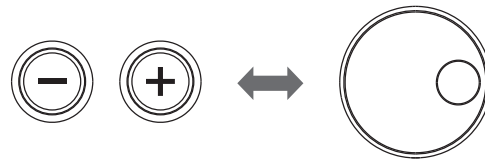

Listening to the Demo Song

- Press [KIT] button and [UTILITY] button simultaneously to enter Demo Mode:

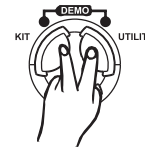

- Press [+] / [-] buttons to select a Demo to play;

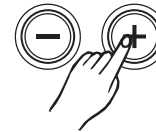

- Use [PLAY/STOP] button control the play.



Choosing a Drum Kit

- Press the [KIT] and the Kit indicator "KIT" is lightened in the screen;

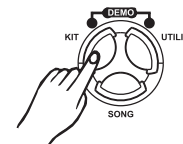

- Press [+] / [-] or DIAL to choose a drum kit.

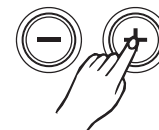

Basic Operations

Play Song

1. Press [SONG], and the SONG screen appears:

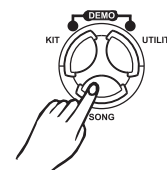

2. Press [+] / [-] or DIAL to choose a song.

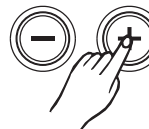

3. Use [PLAY/STOP] button control the play.



Turning the Metronome (Click) On and Off

Press [CLICK] to turn the metronome ON and OFF.
[CLICK] lights while the click sound is set to be played.



100
95
75
25
5
0

Selecting a Drum Kit (KIT)

Important Parameter Here

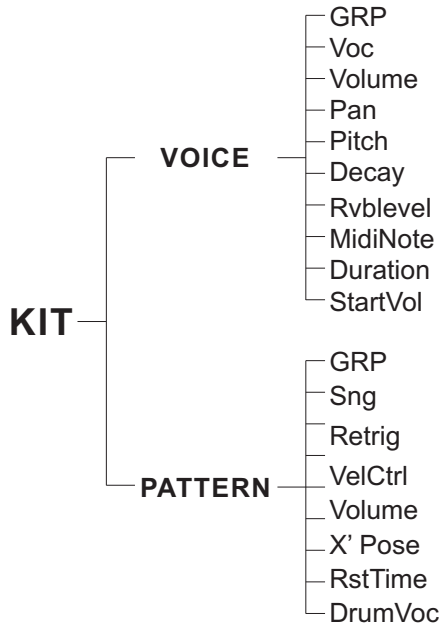

About Drum Kit

This digital drum has 99 (including 40 Preset Kits + 59 User Kits) Kits for you to select.

About Drum Kit Screen

The screen displayed when [KIT] is pressed is referred to as the Drum Kit screen.



1	Kit number
2	Kit name
3	icon "KIT" to indicate the current number displayed is kit number

Selecting a Drum Kit

Enter KIT Mode

- Press the [KIT] button to enter KIT mode.
The Kit indicator "KIT" is lightened and the LCD displays the current Kit number and Kit name like right side.

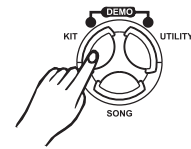

- Press the [+] / [-] button or use the DIAL to select a Kit (next or previous one); Or you can press the [PAGE+] button to quickly jump to next Kit groups (from Preset Kits to User Kits).

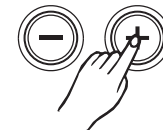

Selecting a Drum Kit

Selecting Pad

The current pad to be edited can be selected either by pressing its Pad Select button or by striking the pad itself.

The digital drum has 10 Pad triggers and 1 pedal controller see Table Trigger MIDI Note below:

PAD	TRIG NUM	NAME	MIDI Note
1	1	KICK	36
2	2	SNARE	38
	3	SNARE RIM	40
3	4	TOM1	48
	5	TOM1 RIM	50
4	6	TOM2	45
	7	TOM2 RIM	47
5	8	TOM3	43
	9	TOM3 RIM	58
6	10	TOM4	41
	11	TOM4 RIM	39
7	12	RIDE	51
	13	RIDE RIM	59
	14	RIDE Bell	53
8	15	CRASH1	49
	16	CRASH1 RIM	55
9	17	CRASH2	57
	18	CRASH2 RIM	52
10	19	Open HIHAT	46
	20	Open HIHAT RIM	26
	21	Half Open HIHAT	23
	22	Half Open HIHAT RIM	24
	23	Close HIHAT	42
	24	Close HIHAT RIM	22
Pedal	25	Pedal HIHAT	44
	26	Splash	21

Note:

1. You can select Close Hi-Hat (Close Hi-Hat Rim) by press Pad Select button [HI-HAT CONTROL] and [HI-HAT] simultaneously.
2. When using Pad Select button, some of the pad trigger can't be selected, for example: RIDE BELL, Half Open Hi-Hat, Half Open Hi-Hat Rim, Splash. And thus, you should strike a pad to select the above triggers.

Meaning for Pad Select button LED

Pad Selected	Pad Select indicator
Ride Bell	[RIDE] sparkling
Half Open Hi-Hat	[HI-HAT] lighten, [HI-HAT CONTROL] sparkling
Half Open Hi-Hat Rim	[HI-HAT] lighten, [HI-HAT CONTROL] sparkling, [RIM] lighten
Close Hi-Hat	[HI-HAT] lighten, [HI-HAT CONTROL] lighten
Close Hi-Hat Rim	[HI-HAT] lighten, [HI-HAT CONTROL] lighten, [RIM] lighten
Splash	[HI-HAT CONTROL] lighten, [RIM] sparkling

Selecting a Drum Kit

Drum Kit Setting

Selecting voices

About the voices

There are 696 different voices which are categorized into 8 separate groups (such as KICK, SNARE, TOM and etc) and 1 hi-hat combination group.

Selecting Pad Voice

1. Press [KIT], then [MENU].
2. Press [SAVE/ENTER]
The voice group name will appear.
3. Press Pad Select button or strike a pad you wish to select.
4. Press [PAGE+]/[PAGE-] button to select "Grp" or "Voc"
"Grp": Type of voice
"Voc": Voice name
5. Press [+]/[-] button or use the DIAL to select the voice group or individual voice.

Grp: There are 8 common Voice group and 1 Hi-Hat Combination.
--8 common Voice group:
"KickBk", "SnareBk", "TomBk", "RideBk", "CrashBk",
"HihatBk", "PercuBk", "SFX"
--1 Hi-Hat Combination (displayed as "HH_Combi") group

Selecting Hi-Hat Combination group

1. Press [KIT], then [MENU]
2. Press [SAVE/ENTER]
3. Press Pad Select button or strike a pad to select the trigger of the Hi-Hat Combination.
There are 8 pad trigger which belong to Hi-Hat combination triggers, for example, open hihat, open hihat rim, half open hihat, half open hihat rim, close hihat, close hihat rim, pedal hihat, splash.
4. Press [+] or use the DIAL to select the last group.
The "HH_Combi" will be displayed just when you select the pad as step 3 described.

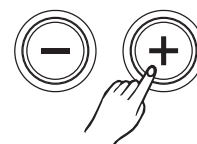
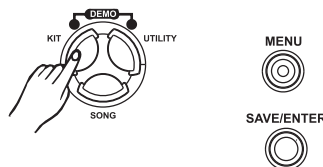
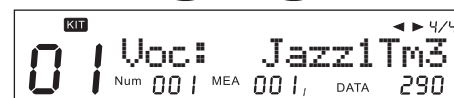
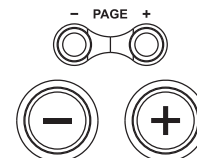
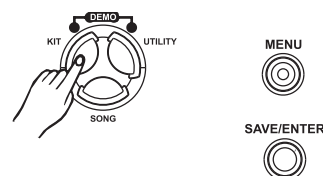

Selecting a Drum Kit

- Press [PAGE+]
The Hi-Hat Combination group name will appear.
- Press [+] / [-] button or use the DIAL to select the one of the Hi-Hat Combination group.
The digital drum has 18 Hi-Hat Combination group, see detail on **Appendices**.

Editing Voices Parameters

- Press [KIT], then [MENU].
- Press [SAVE/ENTER].
The voice group name will appear.
- Press Pad Select button or strike a pad you wish.
- Press [PAGE+] / [PAGE-] button select parameters to be edit.
- Press [+] / [-] button or use the DIAL to Make the setting.

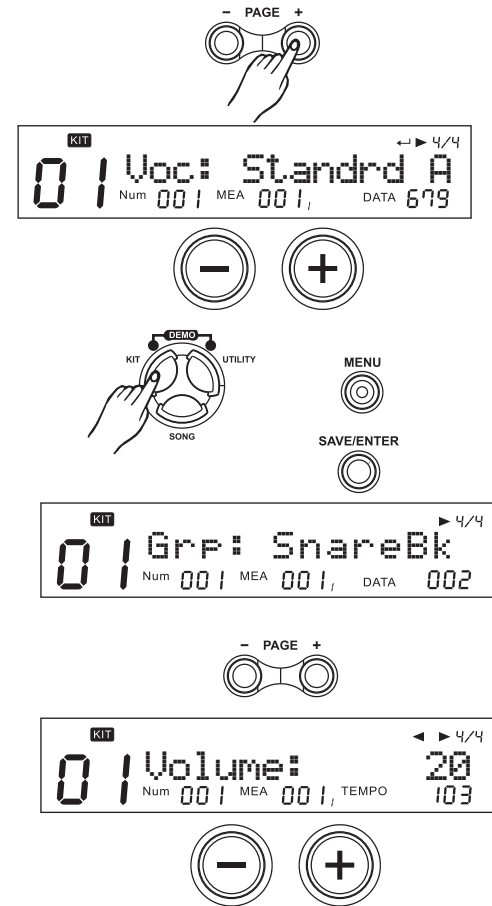

Parameter	Function	Range
Volume	Set volume of each pad voice	0~32
Pan	Set panning of each pad voice	L8~R8/Center
Pitch	Set pitch of each pad voice	-8~+8
Decay	Set decay of each pad voice	-5~0
RvbLevel	Set reverb level of each pad voice	0~32
*MidiNote	Set the MIDI note numbers to be transmitted by each pad.	0~127
Duration	Set the pad note length(the time between note on and note off) for MIDI Out.	0.1s~0.8s
StartVol	Set start volume of each pad voice	0~32

MIDI Note:

Adjust the midi note of each pad triggers sending out through MIDI OUT Port.

For each Pad trigger's default MIDI Note, (See detail as **Table Trigger MIDI Note**).

If two trigger selected the same Midi Note, the LCD will display "!" to suggest you to change another.

Note:

- After selecting HH Combi group, you can adjust the parameter for all the hi-hat pad together, including Open Hi-Hat, Open Hi-Hat Rim, Half-Open Hi-Hat, Half-Open Hi-Hat Rim, Close Hi-Hat, Close Hi-Hat Rim, Pedal Hi-Hat, Splash;
- Distinguishingly, Hi-Hat Pedal volume (including Pedal Hi-Hat and Splash), can be adjusted separately;

Selecting a Drum Kit

Playing a Song by Hitting a Pad (Pad Pattern)

The Pad Pattern function is used to play a pattern by triggering a pad. This function provides a very convenient way to use patterns during a live performance.

Pad Pattern setting

1. Press [KIT], then [MENU].
2. Press [PAGE+]
 - The "PATTERN:" will appear.
3. Press Pad Select button or strike a pad you wish.
4. Press [+]/[-] button or use the DIAL to Switch pad pattern function OFF to ON.
5. Press [SAVE/ENTER] to set parameter. Pad Pattern parameter will be displayed.
6. Press [PAGE+]/[PAGE-] button to select parameters to be set.
7. Press [+]/[-] button or use the DIAL to Make the setting.

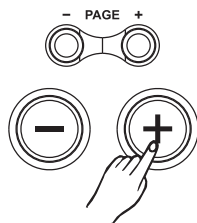
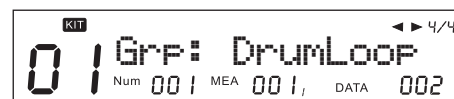
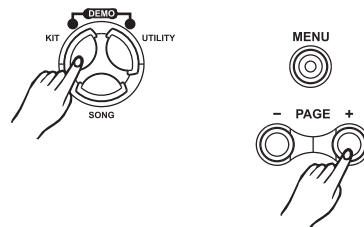

Parameter	Function	Para Range ([+]/[-])
Pattern	Pad Pattern switch	OFF/ON
Grp*	Pad pattern group	DrumLoop/1 Shot/ PercLoop /HIT/TAP/ UserSong
Sng*	Pad pattern index	1~220
Retrig*	retrigger mode	ST/SP、 ReST
VelCtrl*	velocity control volume	OFF/ON
Volume	Volume	0~32
X'Pose	Pad pattern's transpose for melody track	-12~12
RstTime*	reset time	OFF/0.1s~4.0s(unit 0.1s)
DrumVoc*	Whether drum voice sound	OFF/ON

Grp、 Sng:

All the Songs (including Preset Songs, User Songs) can be selected for pad pattern; If you select Hit/Tap as pad pattern song, be sure that the drum module support at most 7 pad be set as Pad Pattern to play Hit/Tap simultaneously. Use the DIAL or press the [+]/ [-] button to select a song you like, when another song group is selected, the menu "Grp:" will refresh simultaneously.

VelCtrl:

This is used to define whether the playback volume is controlled by the velocity of percussion.

ON: Control the volume of the pad pattern's play by trigger velocity

OFF: Playback the song with the default volume (the default volume can be adjusted in the next menu "volume:").

Retrig and RstTime:

When you select the Song of type...

Loop or 1shot: "RstTime" menu displays invalid ("---");

Tap: "Retrig" menu displays invalid ("---");

Hit: RstTime and Retrig menu all display invalid ("---");

Selecting a Drum Kit

DrumVoc:

This is used to define whether to sound drum voice when you strike a pad to trigger/play a song.

ON: Default setting. When striking the pad, playback the song also with drum voice;

OFF: When you strike a pad to trigger a song play, it just playback the song without pad triggering sound.

Exchange Kit Order

1. Press [KIT], then press [+] / [-] button or use the DIAL to select a source user kit.

2. Press [MENU], and then press [PAGE+] [PAGE-] to select the Exchange menu.

3. Press [SAVE/ENTER] to set exchange position.

4. Press [+] / [-] button or use the DIAL to select an destination user kit.

5. Press [SAVE/ENTER] again to finish this setting.

Note:

When exchange operation is done, LCD displays "EXCHANGE OK!" temporarily, 2 seconds later, LCD shows the KIT mode automatically, and original Kit is selected.(as "MyKit001" in this example).

Rename Kit

1. Press [KIT], then press [+] / [-] button or use the DIAL to select an user kit.

2. Press [MENU], then press [PAGE+] / [PAGE-] to select the Rename menu.

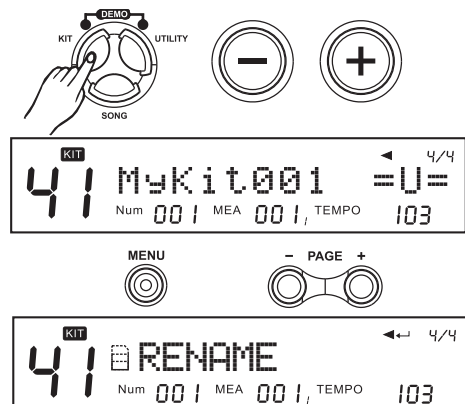
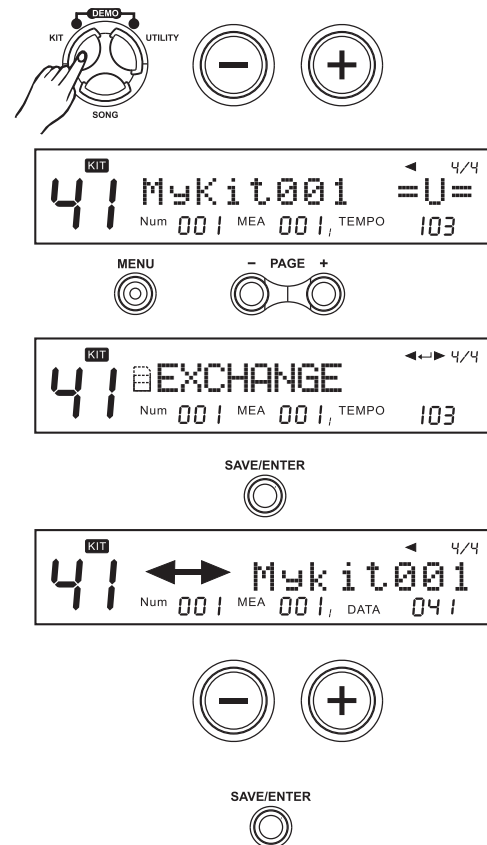

Selecting a Drum Kit

- Press [SAVE/ENTER]
The user name will appear.
- Press [PAGE+]/ [PAGE-] to move the cursor to the character you want to change, then press [+]/[-] button or use the DIAL to select the character.
- Press [SAVE/ENTER] again to finish this setting.

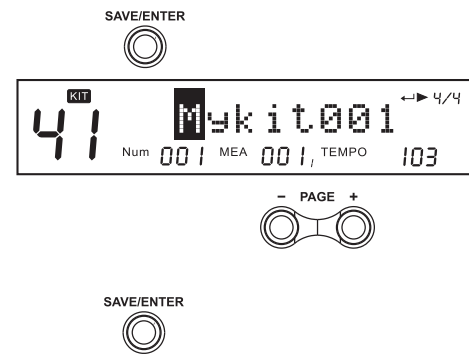

Saving KIT

The digital drum allows modifying and saving preset kits and user Kits in local or SD Card, it is convenient for you to take along and use.

Saving Kit to local

Note:

In the inner of the kit menu, press the [SAVE/ENTER] button, you can also enter saving page to save current kit.

- Press [KIT], then press [+]/[-] button or use the DIAL to select an source kit.
- Press [SAVE/ENTER], then press [+]/[-] button or use the DIAL to select the destination kit
- Press [SAVE/ENTER]. The rename page will appear.
- Press [PAGE+]/ [PAGE-] to move the cursor to the character you want to change, Press [+]/[-] button or use the DIAL to select the character.
- Press [SAVE/ENTER] again to finish this setting.

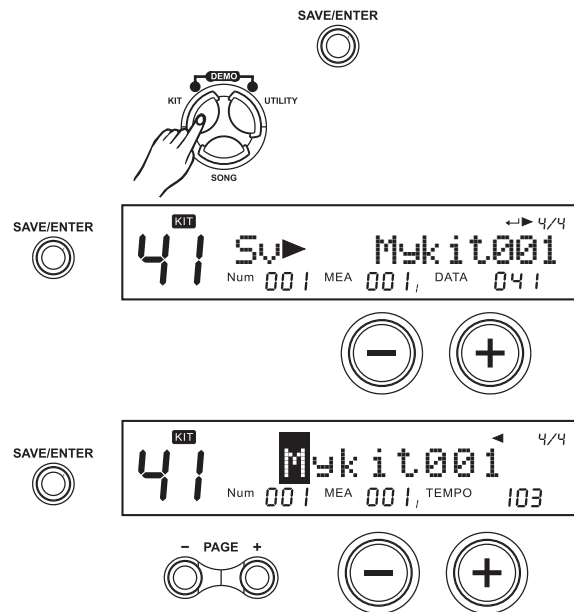

Saving Kit to SD card

- Make sure you insert a available SD card into the slot.
- In the kit screen, select a source kit(user kit) which you want to be saved.
- Press [SAVE/ENTER], then Press [PAGE+]/ [PAGE-] to select page "CurKit▶ Card" or "AllKits▶ Card".
- Press [SAVE/ENTER] to enter rename screen. You can press [PAGE+]/ [PAGE-] or [+]/[-] button and DIAL to change the song name.
- Press [SAVE/ENTER] again to finish this setting.

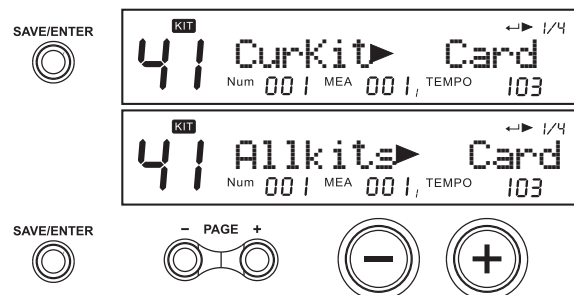

Note:

If the edited Kit is not saved before selecting another Kit or turning off digital drum, changes will be lost.

When saving Kits to SD card, the digital drum will automatically save it (them) on local at the same time, when SD Card is failed to save(for example,it display "No Card" or "Card error!" and etc), the digital drum will also save kit(s) on local.

Using the Mixer (MIXER)

Master Kit volume, Song Volume, Click Volume and Card Volume.
MIDI Volume can be balanced together in the drum module mixer menu.

Master Volume

1. Press the [MIXER] button to enter mixer menu.
2. Press the [PAGE+]/ [PAGE-] button to select "SongVol", "ClickVol" or "CardVol".

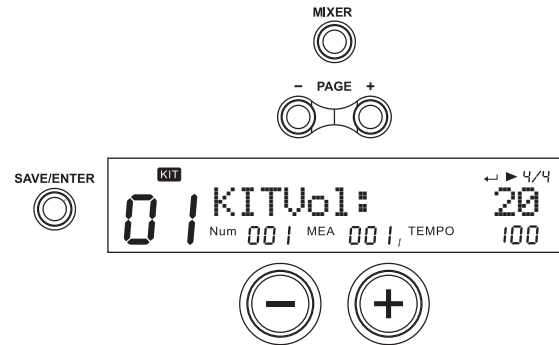

3. Press [+] / [-] button or use the DIAL to adjust each volume.

Inner Volume

--In the menu page "KITVol: 20". Press the [SAVE/ENTER] button to enter kit inner volume page, it will show current pad trigger's volume. You can adjust the value using [+] / [-] or DIAL.

The adjustments of the inner volume equals to the operation in KIT MENU. Don't forget to save current Kit before you select another Kit or power down this digital drum.

--In the menu page "SongVol: 20", press the [SAVE/ENTER] button to enter Song inner volume page, showing current song parts' volumes. You can adjust the value using [+] / [-] or DIAL.

The adjustments of the inner volume equals to the operation in SONG MENU. Don't forget to save current Song before you select another Song or turn off this digital drum.

Note:

ClickVol in mixer menu equals to the "ClickVol" in Click menu.

Parameter	Secondary Para	Function	Value Range
KITVol		Master Kit Volume	0~32
	TrigVol	Current trigger volume	0~32
SongVol		Master Accompaniment Volume	0~32
	DrumVol	Current Song Drum volume	0~32
	PercVol	Current Song Percussion volume	0~32
	Part1Vol	Current Song Part1 volume	0~32
	Part2Vol	Current Song Part2 volume	0~32
	Part3Vol	Current Song Part3 volume	0~32
	Part4Vol	Current Song Part4 volume	0~32
Part5Vol	Current Song Part5 volume	0~32	
CardVol		Card Midi volume	0~32
ClickVol		Click volume	0~32

Song Selection (SONG)

Important Parameters Here

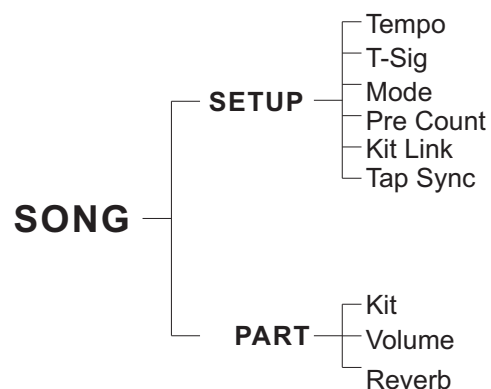

About Song Screen



1	Song number Indicates the number of the currently selected song.
2	Measure number When you press [PLAY/STOP], playback begins from the measure shown here
3	Beat
4	Current Tempo
5	The Beat of this song
6	Song name Indicates the name of the currently selected song.
7	Indicator "song" appears when press [SONG]

About Song

The digital drum comes with 220 songs. Preset (Internal) Songs (Songs 1-120) and User Songs (Songs 121-220).

The digital drum's sequencer organizes music into seven parts. The Drum Kit part is used to record/playback what is played on the pads. Additionally, Percussion part, Part 1, Part 2, Part 3, Part 4 and Part 5 are the 6 backing instrument parts (backing parts). The collective performance of these 7 parts is called a song.

Song Choosing

1. Press [SONG]
The SONG screen appears. In song screen, "*" indicates a new User song.

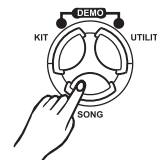

2. Press [PAGE+] / [PAGE-] to select the song category.



3. Press [+] / [-] or use the DIAL to select the Song.

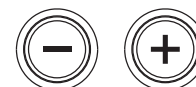

Song Category:

Drum Loop, 1 Shot, Percussion Loop, Hit, Tap, User Song

Song Selection

Song Playing Back

1. Press [PLAY/STOP], then [PLAY/STOP] lights.
(During playback of a song, you'll see the pads' buttons corresponding to the drums being played in the drum part light up.)

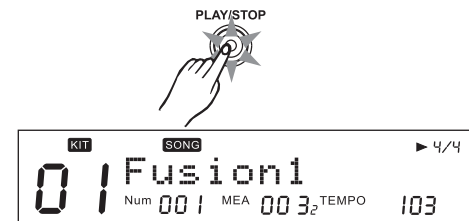

2. Press [PLAY/STOP] again to stop playback of the song, [PLAY/STOP] light goes out. And the song returns to the beginning of the measure that was being played back.



Adjusting Song Acmp Volume

Adjust background volume of the song to balance the Kit volume. (Refer to **MIXER**).

Temporarily Changing the Tempo

You can temporarily change the tempo of a song while playback is in progress. The song returns to its preset tempo when a different song is selected. (refer to **Song Editing**)

Song Editing

Song Setting

1. Press [SONG], then [MENU], "SETUP" will appear.

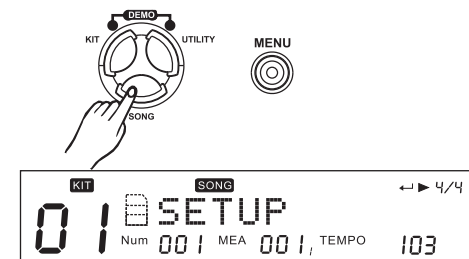

2. Press [SAVE/ENTER].

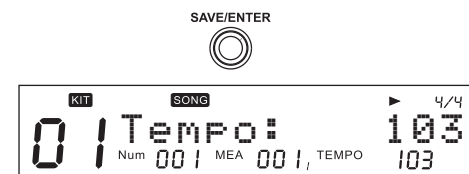

3. Press [PAGE+] / [PAGE-] to select the parameter.

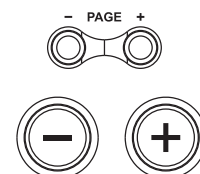

4. Press [+] / [-] or use the DIAL to make the setting.

Note:

The parameters of Pre Count, Kit Link, Tap Sync are global settings, which can not be saved to a user song.

Song Selection

During the playback of a song, the edited parameters take effect at once.

Parameter	Brief Explain	Range
Tempo*	SONG playback rate	30-280
T-Sig*	SONG Beat	1-9/2, 1-9/4, 1-9/8, 1-9/16
Mode*	SONG playback mode	Loop/1 Shot/TAP/HIT
Pre Count*	measures before playback of a song begins	0, 1, 2
Kit Link*	SONG Kit Synchronizing	OFF/ON
Tap Sync*	Tap continuous playback	OFF/ON

Tempo

You can temporarily change the tempo of a song while it is being played back. The song returns to its preset tempo when changed the song number.

T-Sig

For the preset songs, this parameter shows the current song's default value. It can not be changed.

Mode

1. Each Song has its own mode as default.
2. If current song is the type of Loop/1Shot, the parameter can be changed and the modification takes effect at once; if current song is the type of TAP/HIT, the parameter can't be changed.

Pre Count

This is an auxiliary function available when "LOOP" and "1 SHOT" are specified as the Play Mode for the song.

You can have a count sound (click) inserted before playback of a song begins.

- 0: Playback begins without a count-in.
- 1: Playback begins after a 1-measure count-in.
- 2: Playback begins after a 2-measure count-in.

Kit Link

This is an auxiliary function available when "LOOP" and "1 SHOT" are specified as the Play Mode for the song.

ON: While selecting song, the kit would be changed according to the drum part of current song.

--During playback of a song, the function will take effect at once while switched from "OFF" to "ON".

--If you want to change some other kit for your performance, you can simply enter Kit mode to select a different kit.

OFF: While you are selecting songs, the kit won't be changed with the songs.

Tap Sync

This is an auxiliary function available when "TAP" and "HIT" are specified as the Play Mode for the song. In Tap and HIT playback, this setting allows you to either have the previous sound stop and the subsequent sound start playing (OFF) or have the two sounds layered (ON) if one sound is set to play before the previous sound has finished playing.

ON: The previous sound continues to play to the end, while the subsequent sound is superimposed on it.

OFF: The previous sound stops while in progress, and the subsequent sound starts playing.

Part Settings (Drum/Perc/Part1~Part5)

Drum/Perc Part

1. Press [SONG], then [MENU].
2. Press [PAGE+], "PART: DRUM" will appear.
3. Press [+] / [-] or use DIAL to select the corresponding part.
4. Press [PAGE+] / [PAGE-], select setting menu.
5. Press [+] / [-] or use the DIAL to adjust settings of the corresponding parameters.

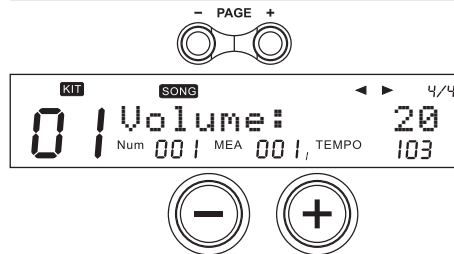
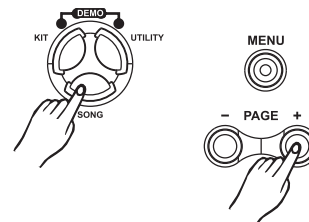

Parameter	Brief Explain	Range
Kit Set	Kit Number applied for drum part	1-109 (include GM KIT) 1-99 (if programmed with Local Kit) 100-109 (if programmed with GM Kit)
Volume	Part Volume	0~32
Reverb	Part Reverb	0~32

Part1~Part5

1. Press [SONG], then [MENU]
2. Press [PAGE+], the "PART:" will appear.
3. Press [+] / [-] or use the DIAL to select Part1~Part5.
4. Press [SAVE/ENTER] enter the screen of part settings.
5. Press [PAGE+] / [PAGE-], to select setting menu.
6. Press [+] / [-] or use the DIAL to adjust settings of the corresponding parameters.

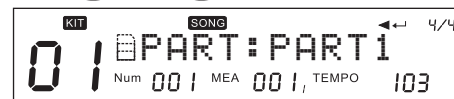
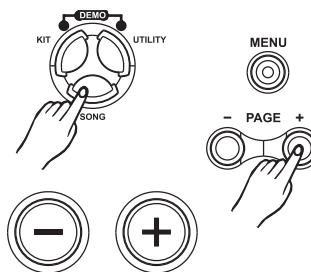

Parameter	Brief Explain	Range
Voc*	Voice applied for part1~part5	1~128
Volume	Part volume	0~32
Pan	Part pan	L8~Center~R8
Reverb	Part reverb	0~32

Voc:

Each preset song has its default voice.

Song Selection

Note:

While setting this parameter, "DATA:" displayed in right bottom of the LCD shows the number of the current voice.

Erase a Song

Attention: This is an auxiliary function available when song category is User Song, and the song is not empty.

1. Press [SONG], then press [+] / [-] or use the DIAL to select the user song (note empty).
2. Press [MENU]
3. Press [PAGE+] to select "ERASE"
4. Press [+] / [-] or use the DIAL to select the part to be erased. In addition, you can select "ALL" to erase the whole user song.
5. Press [SAVE/ENTER], the screen displays as right side.
6. Press [SAVE/ENTER] for make sure. When you have finished deleting the song, the completed screen appears.
7. Press [EXIT] to cancel the operation, it will return to screen of "Erase:"

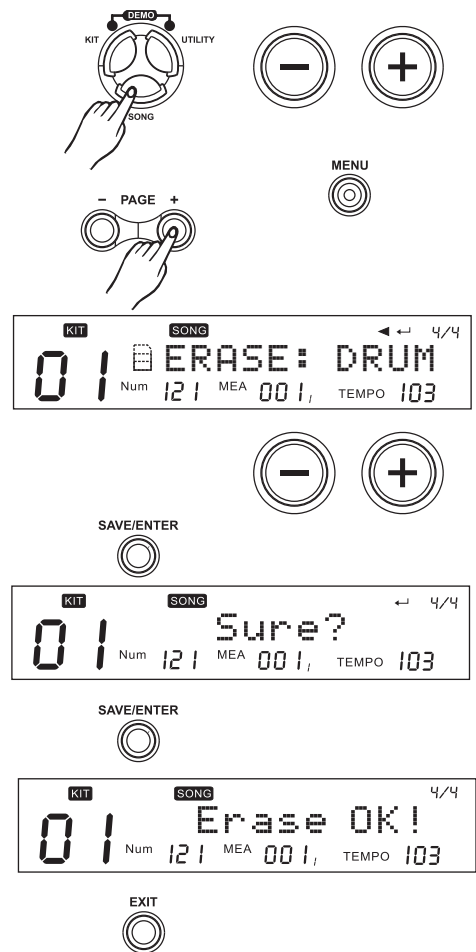

Saving Song

The digital drum allows you to edit preset song and save it to user song for using conveniently. Also it allows saving current user song and all user songs to SD card.

Note:

Not only on SONG screen, but also in the deeper menu of song editing, press [SAVE/ENTER] will enter Song Save screen.

100
95
75
25
5
0

Song Selection

Saving Song to Local

1. In the song screen, select a source song (preset song or user song) which you want to saved.
2. Press [SAVE/ENTER], then press [+]/[-] button or use the DIAL to select the destination song.
3. Press [SAVE/ENTER] to enter rename screen.
4. Press [PAGE+]/ [PAGE-] or [+]/[-] button and DIAL to change the song name.
Press [SAVE/ENTER] again to finish this setting.

The editing of the parameter on preset song will take effect at once, but after you change to another song before saving, the edited parameter will be lost. For saving these editing, you can save the edited preset song to user song.

Note:

After you have edited the parameters, and did not save the song before powering off, the unsaved changes would be lost.

Saving Song to SD Card

1. Make sure you insert a available SD card into the slot.
2. In the song screen, select a source song(user song) which you want to be saved.
3. Press [SAVE/ENTER], then Press [PAGE+]/ [PAGE-] to select page "CurSng▶ Card" or "AllSngs▶ Card".
4. Press [SAVE/ENTER] to enter rename screen. You can press [PAGE+]/ [PAGE-] or [+]/[-] button and DIAL to change the song name.
5. Press [SAVE/ENTER] again to finish this setting .

Note:

If there is not enough memory on SD card, new song also will be saved to local; If both local and SD card did not have enough memory for saving, then the digital drum will show hints and cancel the operation of saving.

Individual Song Saving

- If no identified SD card, you can save song to local, reference operation as "Saving Song to local"
- If exist identified SD card, you need enter menu to select file type for saving (CurSng/AllSngs) and saving position (Local/Card) reference operation as "Saving Song to SD card".

All User Song Saving

First, be sure that you insert available SD card in digital drum card slot. Refer to "**Saving Song to SD Card**" select "AllSngs▶ Card" and make sure for saving.



Muting a Selected Part (PART MUTE)

Mute On

Press [PART MUTE], the [PART MUTE] lights then the mute is on;
 In SONG mode you can mute Song parts (drum, percussion, part1~part5);
 In Card mode, you can mute each SD card MIDI Song channel (Channel 1~
 Channel 16);



Mute Off

When mute on, press [PART MUTE] button to shut down mute function; [PART MUTE] led is dark.

Setting Mute

Mute a part of Song

- When you press [PLAY/STOP] button and play a song, (whatever in KIT mode, UTILITY menu .etc), press and hold [MENU] button, then press [PART MUTE] button to enter the mute menu and choose the parts for mute of current song.
- Then press [+]/[-] button or use the DIAL to select the mute part.

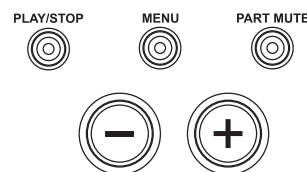

Part	Function
SngDrum	Mutes only the drum instruments in the drum part (the percussion instruments still sound). This is convenient when performing with Preset songs.
Acmp	Mute percussion part and part1~part5.
Drm/Prc	Mute drum and percussion parts.
Part1-5	All Parts 1-5 are muted.
Part1 Part2 Part3 Part4 Part5	The individual part is muted.

Mute a Channel of the MIDI File

- When browsing the SD card, press and hold [MENU] button, then press [PART MUTE] to select the settings of the mute option.
- You can press [PAGE+]/[PAGE-] buttons or use the DIAL to select any of the 16 channels ,and press [+]/[-] buttons to set it muted when the part mute function is enabled. (default setting: CH10 Mute; other channels are "Play")

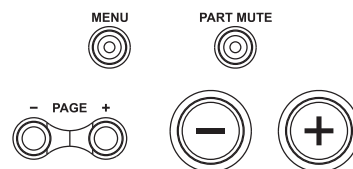

Note:

When the current play type is changed (switch card mode to song mode, or vice versa), MUTE function should be shut down automatically.

Record(RECORD)

100 user songs can be recorded, each song has 7 record tracks (Drum + Percussion + Part1~Part5), in which Part1~Part 5 can only be recorded by MIDI IN.

Record a New Song

1. Select a new song (behind of the song's name, there is a "*" icon), then press the [REC] button to enter record menu. The click would be started automatically. The [REC] button is lightened. At this time, if SYNC start is ON, [PLAY/STOP] button would spark; if not, [PLAY/STOP] button would be darkened.
2. Choose "QUICK RECORD" (without any setting step, you can immediately start recording) or common "RECORD".

Quick Record

Without any setting step, you can immediately start recording drum. In Quick Record, what you record is what you hear (without click sound), it can't be quantized or make other record setting.

1. Press [REC] button and [PART MUTE] button simultaneously to enter recording statement.
 - a) If current song is a NEW song, start to record its drum part;
 - b) If current mode is not the song mode (for example KIT mode or UTILITY menu etc), assign a NEW song automatically to start drum part recording;
 - c) If the drum part of the current user song already have data, then delete original drum part and record new.
2. In Quick Record, SYNC start is always ON, trigger the pads to start recording; or you can press [PLAY/STOP] button to start too. In recording statement, both the [REC] button and [PLAY/STOP] button are lightened; LCD displays "Recording..."
3. In recording statement, press [REC] button to enter rehearsing statement, in which nothing can be recorded but time is passing. At this time, the [REC] button is sparking, [PLAY/STOP] button is lightened; LCD displays "-Rehearsal-". Press [REC] button again to go on recording, back to recording statement.
4. Press [PLAY /STOP] button again to stop recording.

Record

1. Start Recording

Recording Drum/Percussion Parts

In record waiting statement, press [PLAY/STOP] button or trigger the pads (when SYNC Start is ON) to start recording. LCD displays "Recording...", the measure and beat icons would refresh. At this time, Both [REC] button and [PLAY/STOP] button would be lightened.

Note:

- CLICK sounds could not be recorded.
- In recording statement, you could not adjust the tempo value, and tempo changes can not be recorded too.

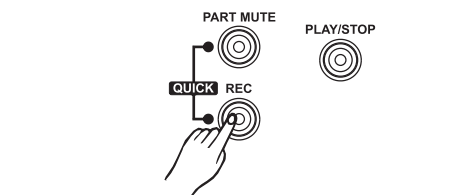
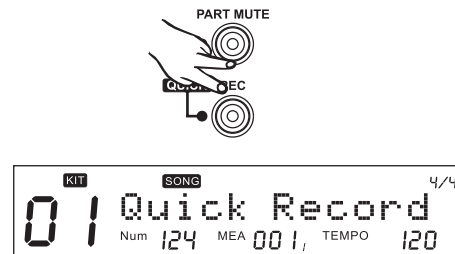
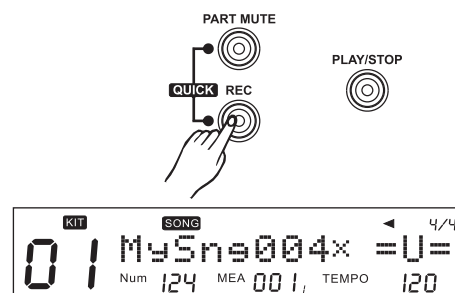

Record(RECORD)

Recording Part1~Part5

Link MIDI keyboard (or other MIDI equipment such as computer) to the MIDI IN port of digital drum;

Press [PLAY/STOP] button to start recording. The midi channel 12~16 would be recorded to corresponding part.

MIDI Channel	Part
12	Part 1
13	Part 2
14	Part 3
15	Part 4
16	Part 5

2. Stop recording

In recording statement, press [PLAY/STOP] button or [EXIT] button to stop recording. The [REC] button and [PLAY/STOP] button are putting out.

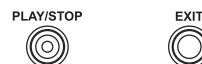

3. Playback

After recording stops, it would enter SONG Mode automatically; Press [PLAY/STOP] button to playback the song you just recorded.

Note:

- In recording statement, press [REC] button to enter rehearsing statement, in which nothing can be recorded but time is passing. At this time, the [REC] button is sparking, [PLAY/STOP] button is lightened; LCD displays “-Rehearsal-”
- Only 1 drum part or percussion part can be recorded at one time, other parts (part1~part5) can be recorded simultaneously.
- Some preset songs are using GM kits for percussion part. In this case, the digital drum will automatically choose "new" as REC mode. Because some percussion voice of GM kits are using the notes out of the range of an internal KIT, if you choose "overdub" mode to add new notes to the percussion part, some previous notes which were arranged in GM kits may be not able to hear.

Recording Based on Preset Song

1. Select a preset song (for example 021), press [REC] button, the digital drum indicates saving it to a user song. It would select the first new user song to be the destination (if there is no new user song, select the very first user song): LCD icon "NUM: 021" indicates that the original song index is 021.

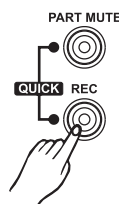

2. Press [+] / [-] buttons to select a proper user song.

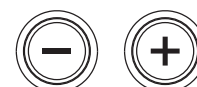

3. Press [SAVE/ENTER] button to confirm and enter rename menu.



4. Then press [SAVE/ENTER], LCD displays “Save Ok!” temporarily; 2 seconds later, LCD displays record menu as right.

5. The click would be started automatically the [REC] button flashes; At this time, if SYNC start is ON, [PLAY/STOP] button would spark; if not, [PLAY/STOP] button would be darken.



Record Setting

1. Press [REC] button, enter record standby status. The display will show record setting page as right:
2. Press [PAGE+]/ [PAGE-] to select the parameter you wish to edit.
3. Press [+]/[-] or use the DIAL to choose the record part and make record setting.

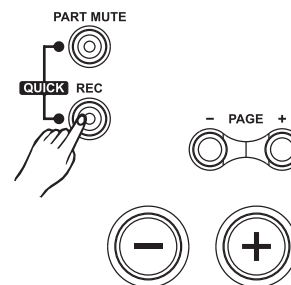

Parameter	Function	PARA RANGE ([+]/[-])
Part*	Select record part	Drum/Perc
TimeSig	record time signature	1-9/2, 1-9/4, 1-9/8, 1-9/16
Tempo	tempo	30~280
Mode*	record mode	New/Overdub
Loop*	loop length	OFF/ALL/1~99
Qntize*	Quantize resolution	OFF/8/8T/16/16T/32/32T/64
Sync-ST	synchronous start	OFF/ON
Precount	Set pre-count measure	0~2

Part

Record drum or percussion part(Part1~Part5 should also be recorded if ch12~ch16 of MIDI IN have notes).

Note:

When select the part Perc and its original voice is GM KIT, you can only record in NEW mode.

Mode

-Refer to **Drum/Percussion Parts:**

Overdub: Record based on the original data of current song part ("Part:");

New: Delete the original data of current song part and record a new one.

- Refer to **Part1~Part5:**

Always record based on the original data of current song Parts.

Loop

OFF: 1 shot;

1~99: loop 1 ~ 99 measures; (If you record a song based on a preset song, it will not display from 1 to 99. For example, if you choose Fusion1 as a preset song, it will display "9"~99 which is longer than the length of the song "Fusion1".)

All: Loop all measure (it appears only when current song is not a new one);

Qntize

1. Quantize all the parts which are being recorded, including drum, percussion, part1 ~part5;
2. Refer to note on: quantize the note starting position but not note length;
3. Refer to controllers: NOT quantize.

Record(RECORD)

The Error Information during Recording

LCD Display	Explain
Too Large	Exceed one song space limited (more or less 2.5K notes)
Space Full	Exceed all User song space limited (64K)

Setting the Metronome (CLICK)

Click On/Off

You can switch the click sound on and off by pressing [CLICK]. [CLICK] flashes while the click sound is set to be played.

Note:

In DEMO,[CLICK] is invalid.

Click Settings

1. Holding down [MENU] and pressing [CLICK] enter the screen of click settings.
2. Press [Page+]/[Page-] to select menu of click settings.
3. Press [+] / [-] or DIAL to adjust parameters.

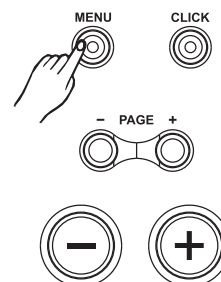

Note:

During click playing, entering the menu of click settings will not interrupt playback of click.



Parameter	Function	PARA RANGE ([+]/[-])
ClickVol	The volume of the click sound	0~32
TimeSig*	Click time signature	0-9/2, 0-9/4, 0-9/8,0-9/16
Interval	Click playback Interval	1/2,3/8,1/4,1/8,1/12,1/16
Voc	Selecting the Click voice	Voice/Metro/Claves/Sticks/Cowbell/Click

TimeSig:

Specify the time signature of the click sound. When the beat per measure is set to "0", no accent is added to the first beat.

Note:

During playback of a song, time signature can not be edited.

Save Data(SAVE)

ALL User Kits, user Songs and Global Setup (including click, pad, and mixer setting .etc) can be saved in SD Card.
See the default saving path:

File Type	Format	Saving Path
user Kit	*.KIT	..Root\ MY_EDRUM \
All user Kits	*.KIT	..Root\ MY_EDRUM \
user Song	*.MID	..Root\ MY_EDRUM \
All user Song	*.SNG	..Root\ MY_EDRUM \
Global Setup	*.SET	..Root\ MY_EDRUM \

Saving User Kit

Refer to “**Saving Kit**”

Saving User Song

Refer to “**Saving Song**”

Saving Global Setup

1. Be sure that your SD Card is inserted and valid.
2. Press [UTILITY] button, then Press [Page+] to select the “SAVE GLOBAL” screen.
3. Press [SAVE/ENTER] to enter rename screen. You can press [PAGE+]/ [PAGE-] or [+]/[-] button and DIAL to change the file name.
4. Keep pressing [SAVE/ENTER] till you finish the save operation.

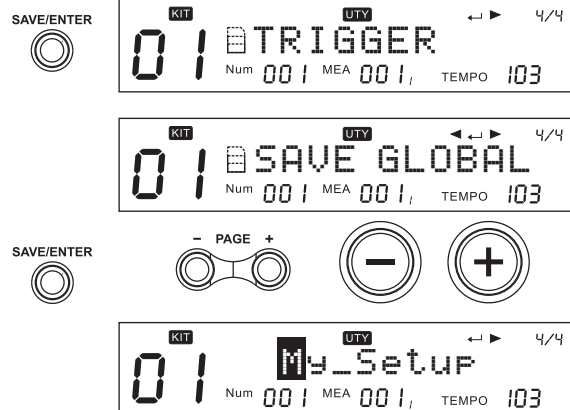
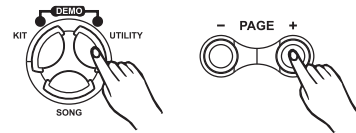

Pad and Trigger Setting(UTILITY)

You can set the parameters of each drum pad and cymbals in the Trigger menu. During the setting, you can select each trigger by hitting the corresponding trigger or use the drum buttons on the panel.

1. Press [UTILITY] button to enter the utility menu. The display will show "TRIGGER".

2. Press [SAVE/ENTER] to enter the Trigger parameter menu. Press Pad Select button or strike a pad you wish.

3. Then Press [Page+]/[Page-] to select the parameter to be setting.

4. Press [+]/[-] button or use the DIAL to make the setting.

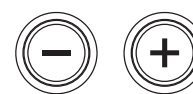

Parameter	Function	PARA RANGE ([+]/[-])
Sensitive*	Sensitivity	1~32
Thresh*	Threshold	0~31
Curve*	Trigger curve	Normal/Exp1/Exp2/Log1/Log2 /Loud
Retrig-C*	Retrigger cancel	1~16
X-Talk*	Cross talk	0~16
Rim-Adj*	Rim Shot Adjust	0~16
Splash-S*	Splash sensitivity	1~8

Sensitive(Sensitivity)

Adjust the sensitivity of the pad to regulate the pad response. Higher settings result in higher sensitivity, so that the pad will produce a loud volume even when struck softly.

You can also adjust the sensitivity of the splash in SPLASH SENSITIVITY.

Thresh(Threshold)

This setting allows a trigger signal to be received only when the pad is struck harder than a specified force. This can be used to prevent a pad from sounding in response to extraneous vibrations from another pad.

100
95
75
25
5
0

Pad and Trigger Setting(UTILITY)

Curve (Trigger curve)

This setting allows you to control the relation between the velocity (striking force) and changes in volume (the dynamic curve.) Adjust this curve until the response feels as natural as possible.

Normal: The standard setting. This produces the natural correspondence between the strength of the strike and the change in volume.

Exp1/2: Compared to Normal, a strong strike will produce a greater change.

Log1/2: Compared to Normal, a soft strike will produce a greater change.

Loud: Changes made in response to the striking force are minor. When using drum triggers, these settings help maintain stable levels.

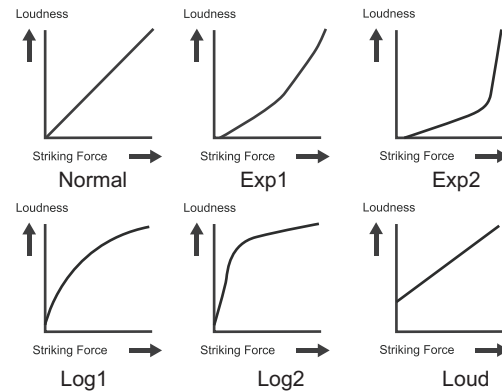

Retrig-C (Retrigger cancel)

Playing snare drum pads and other devices with commercially available acoustic drum triggers attached may result in altered waveforms, which may also cause inadvertent sounding. This occurs in particular at the decaying edge of the waveform. Retrigger Cancel detects such distortion in and prevents retriggering from occurring. Although setting this to a high value prevents retriggering, it then becomes easy for sounds to be omitted when the drums played fast (roll etc.). Set this to the lowest value possible while still ensuring that there is no retriggering.

X- Talk(Cross talk)

When two pads are mounted on the same stand, the vibration produced by hitting one pad may trigger the sound from another pad unintentionally (This is called crosstalk.) You can avoid this problem by adjusting Crosstalk Cancel on the pad that is sounding inadvertently. If the value is set too high, then when two pads are played simultaneously, the one that is struck less forcefully will not sound. So be careful and set this parameter to the minimum value required to prevent such crosstalk. With a setting of "0", crosstalk prevention does not function.

Rim-Adj

There are some cases that you have a rim sound unexpectedly when you hit head strongly. You can improve this situation with decreasing this value.

When select Snare/Tom1~Tom4 or the trigger rims, the parameter displays the RimShot value; if not, it displays "---".

Splash-S

When select P HIHAT or Splash, the parameter displays the splash sensitivity; if selected other invalid triggers, it displays "---".

Setting Effect (REVERB/EQ)

You can set the Reverb effect and the 4 band EQ parameters in the “Effect” menu.

1. Press [UTILITY], then [Page+] button to select the effect menu.
2. Press [SAVE/ENTER] , then Press [Page+]/[Page-] to select the parameter to be setting.
3. Press [+] / [-] button or use the DIAL to make the setting.

Note:

If you want to save all the effects for current kit, see **Saving KIT**.

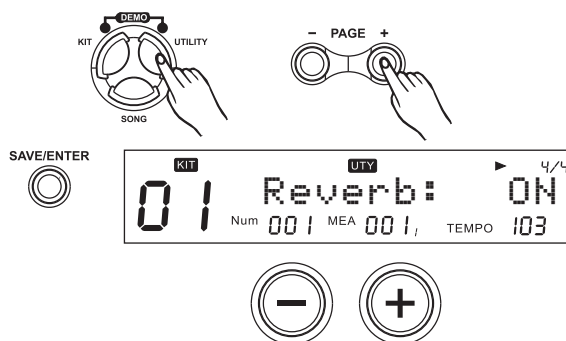

Parameter	Function	PARA RANG
Reverb	Master reverb switch	OFF/ON
RvbTyp	Reverb type	SRoom/MRoom/LRoom/Hall1/Hall2/Plate/Delay/P.Dely
EQSwitch	4 band EQ master switch	OFF/ON
EQLow	EQ low band	-12dB~12dB
EQL.Mid	EQ low middle band	-12dB~12dB
EQH.Mid	EQ high middle band	-12dB~12dB
EQHigh	EQ high band	-12dB~12dB

MIDI Settings

You can connect this digital drum to other MIDI device or PC thru standard MIDI cable or USB cable.

1. Press [UTILITY], then [Page+] button to select the MIDI SET menu.
2. Press [SAVE/ENTER] , then Press [Page+]/[Page-] to select the parameter to be setting.
3. Press [+] / [-] button or use the DIAL to make the setting.

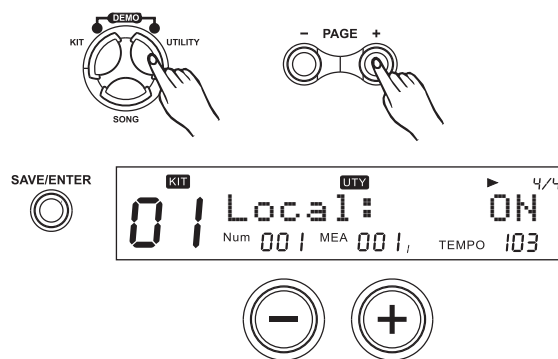

Item	Function
Local*	ON: Output both local sound and MIDI data. OFF: Mute the local sound, only output MIDI data.
SoftThru	ON: Forward all input MIDI data to MIDI out. OFF: Only output local MIDI data.
GM Mode	ON: Channel 10 will play the GM percussion kits. OFF: Channel 10 will play the digital drum internal kits.

Local

OFF: Mute the local sound just when triggering the pad. Press the Pad Select buttons would always sound.

Setting Effect (REVERB/EQ)

Factory Reset

1. Press [UTILITY], then [Page+] button to select the RESET menu.
2. Press [SAVE/ENTER] ,then Press [Page+]/[Page-] to select "ResetPara" or "ResetAll".
3. Press [SAVE/ENTER] again to finish the setting.

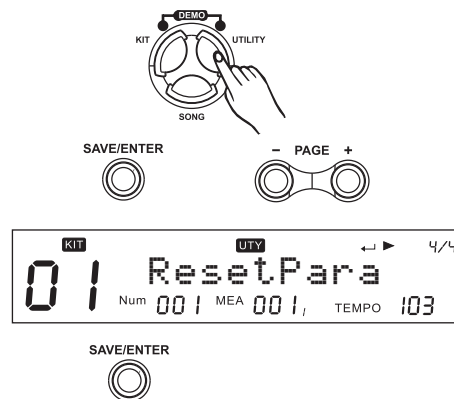

Item	Function
Reset Para	Reset only global settings (MIXER, UTILITY trigger settings, CLICK, Song setup, etc.).
Reset All	Reset the global setting and all user songs, user kits. After the operation, it will back to the main screen display.

Automatic Shutdown

This function is used to set the time of automatic shutdown:
30、60、OFF

1. Press [UTILITY], then [Page+] button to select the AUTOPOWER menu.
2. Press [SAVE/ENTER], the LCD displays the time value. Use [+]/[-] or Data Dial to change time value.
3. The default automatic shutdown time is 30 minutes.



SD Card Operation(CARD)

Search for the Files in a SD Card

1. Press the [CARD] button, the button would be lightened.
You'll see the folders and the supported files in the folder.
The digital drum can support *.MID, *.KIT, *.SNG, *.SET files.
2. By pressing the [+]/[-] button or using the DIAL, you can browse through the files in a folder.
The files are sorted according to their types and names.
3. By pressing the [PAGE+] or [PAGE-] button, you can jump to the first file of the next file type.
4. When a folder is selected, you can press [SAVE/ENTER] button to enter the folder.

Note:

- If there's no folders or supported files in current directory, "No File!" would be shown and you can use [EXIT] button to exit to the last directory you were browsing. If there's more than 128 folders or supported files in current directory, "Too Many File!" would be shown.
- The digital drum supports SD and SDHC card from 16M to 32G, it supports FAT16 and FAT32. The digital drum does not support a SD card which contains more than 1 partition, in this case, only the first partition can be opened and browsed.
- We strongly recommend use the SD card formatted by digital drum.

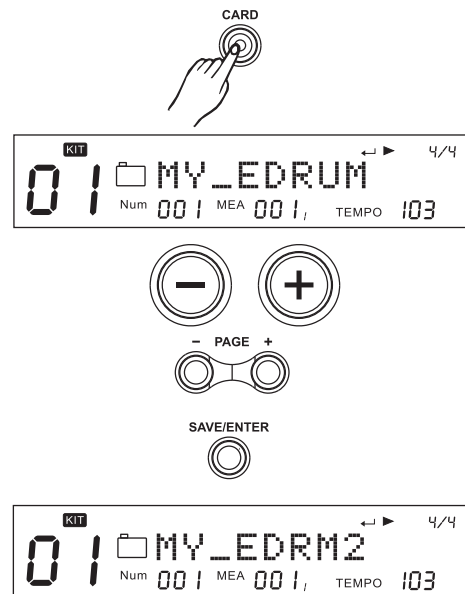

Playback MIDI Files in a SD Card

Playback

1. When a new MIDI file is selected, the initial tempo and time signature would be refresh in less than 1 sec if the playback is not started. Press the [PLAY/STOP] button, the playback will start.
2. During the playback, press [PLAY/STOP] again can stop the playback.

Note:

- You can set up the file loop rule in the MENU of card.
- The digital drum can support SMF 0 & 1(the amount of track should be less than 32). PPQN <= 1024. The maximum single MIDI file size is 542 Kbytes.

Mute a Channel of the MIDI File

When browsing the SD card, press and hold [MENU] button, then press [PART MUTE] to select the settings of the mute option.

You can select any of the 16 channels to be muted when the part mute function is enabled.

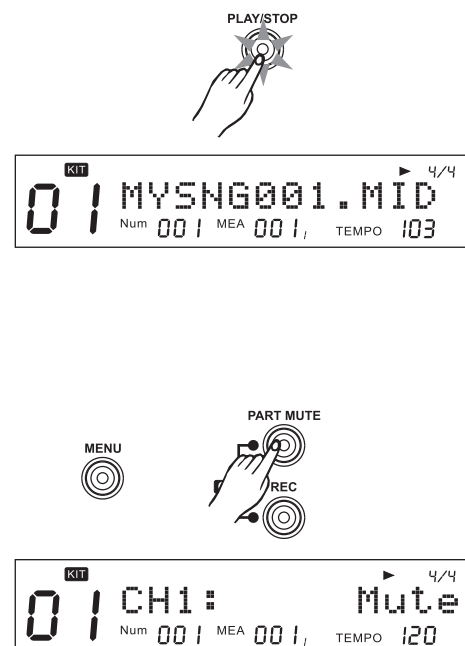

SD Card Operation(CARD)

File Operations

You can easily delete a file, load back your previous settings, format the card or even put your favorite song into the digital drum as a user song by using the SD card menu.

1. Press [MENU] button when browsing the card to enter the card menu.



2. Use [PAGE+] or [PAGE-] to select operations.



Note:

“Load” and “Delete” are shown only when the current selected item is a file (not folder).



Operation	Function	Parameters
LOAD	Load current file	/
DELETE	Delete current file	/
LOOP	Select loop mode of the playback	□/1
PRECOUNT	Set the pre-count of playback	0, 1, 2
FORMAT	Format the card	/

LOAD

You can load a MIDI file to be a user song, or load back the setting of the Kits (*.KIT), all user songs (*.SNG), or your global setting (*.SET).

E.g. if you want to load a MIDI file to be a user song, after you've selected the “Load” in the card menu.

1. Press [SAVE/ENTER] button, you'll be asked to select the type of the user song after the MIDI file is loaded. Use [+], [-] or DIAL to select among 1 Shot, Loop, Tap and Hit.



2. Press [SAVE/ENTER] to confirm your selection, you will be asked to select the user song memory slot which should be used to save the new song. If there's a “*” before the name of the selection, it means it's empty and it's safe to save the new song into it without worrying about losing your previous data.



3. Press [SAVE/ENTER] to confirm your selection. If you have selected a user song memory slot which is not empty, we will ask you to confirm the over write operation. You can use [SAVE/ENTER] to confirm or use [EXIT] to go back to the last step and change your selection.

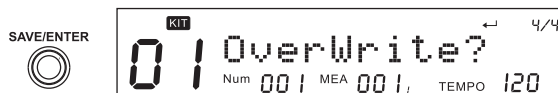

4. If you confirm the selection, the MIDI file would be loaded to the selected user song memory slot, and you will see “Song Loaded!”



SD Card Operation(CARD)

Note:

Only MIDI files smaller than 32 Kbytes can be loaded.
The load user song function support SMF 1 only, and up to 7 channels of the MIDI file can be used in the 1 shot or loop type user song. For TAP or HIT, only 1 channel can be used. Here's the table for the available channel.

1 Shot / Loop:

MIDI Channel	Part	Note
10	Drum	Set controller 0 to select bank as 127 to use internal KIT, otherwise GM kit would be used.
11	Percussion	
12	Part 1	
13	Part 2	
14	Part 3	
15	Part 4	
16	Part 5	

Tap/Hit

Only the first of channel 12~16 in the MIDI file would be used.

Note:

If you load the MIDI file to a user song which is not empty, the original User Song would be deleted even when displays "No Space".

Error information when loading a file:

LCD Displays	Explain
NoUsableData	There's no usable notes in the MIDI file.
FileError	File error.
FileTooBig	The MIDI file is larger than 32 Kbytes.
No Space	The user data space is full.

DELETE

1. Select "Delete" in card menu, press [SAVE/ENTER], then it will ask you to confirm the operation.
2. Press [SAVE/ENTER] to confirm or press [EXIT] to abort.
After the deletion, the display will go back to the folder you were browsing. If there are no supportable files in the folder, "No File!" would be shown.

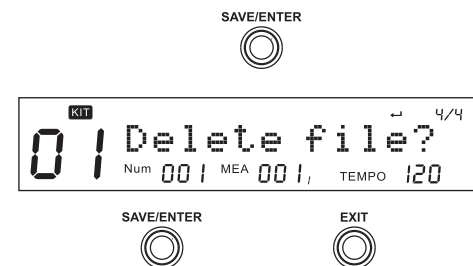

LOOP

1. Select "LOOP" in card menu.
2. Press [+] / [-] button or using the DIAL to select the loop type.
 - ☐: It would loop through all the MIDI files in current folder.
 - 1: It would loop for the current MIDI file only.

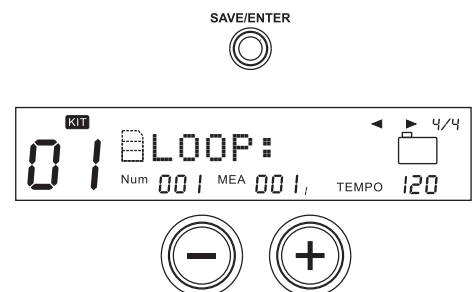

SD Card Operation(CARD)

FORMAT

1. Select "Format" in card menu, press [SAVE/ENTER], it will ask you to confirm the operation.
2. Press [SAVE/ENTER] to confirm or press [EXIT] to abort.

Note:

1. After format, all previous data in the card will be erased. Please make sure that you have backed up all the important information in the card.
2. The digital drum support FAT16 and FAT32 only, some SD card with small capacity (under 32M) may be using FAT12, in this case, the card would be formatted into FAT16.

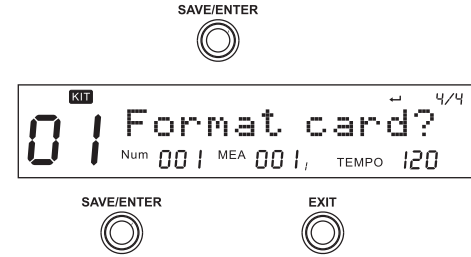

The Error Information during a Card Operation

You may see some error information during a card operation. They are caused by the hardware or file system error of the SD card.

LCD Display	Explain
No Card!	The card is not properly inserted into the card slot.
Card Locked!	The card is found protected/locked during save/delete or format.*
Card Error!	A fatal error occurred during reading or writing the card. **
FS Error!	The file system of the card is not supported. ***

*Please take out the card, unlock the card and try again.

**The fatal error can be caused by a damaged card, poor contact, etc. Please clean the metal connection part of the card and try again.

***digital drum can support only FAT16 and FAT32.

Making the Settings for MIDI

About MIDI

MIDI (Musical Instrument Digital Interface) is a standard that allows performance data and other information to be exchanged among electronic musical instruments and computers. With a MIDI cable connecting MIDI connectors equipped device, you can play multiple instruments with a single keyboard, have multiple instruments perform in ensemble, program the settings to change kits automatically to match the performance as the song progress, and more.

MIDI Connection

MIDI IN: This terminal receives MIDI data from an external MIDI device.

MIDI OUT: This terminal transmits data from the digital drum to other MIDI devices.

USB Connection

The USB connector allows you to connect the digital drum directly to your computer. It can be connected without installing a driver in Windows XP/Vista/Win7 or MAC OSX environments. The digital drum will be recognized as a "USB Audio device" to receive and transmit MIDI messages through a single USB cable. The USB port is used only for MIDI messages (MIDI via USB)

Note:

When the USB port is connected to a computer, all MIDI messages will be received and transmitted via USB.

Connecting with an External Sound Device

The digital drum transmission channel for the drum kit is fixed to Channel 10. It will output MIDI data generated by the triggers when hitting the pads or stepping on the Hi-Hat control pedal (Note ON/OFF, and Foot messages). Song playback data and metronome notes are not transmitted.

Recording Your Performance to an External Sequencer

1. Connect the MIDI OUT of the digital drum to the MIDI IN of your sequencer, and the MIDI OUT of your sequencer to the MIDI IN of the digital drum. If you are using a software sequencer on a computer, you can simply connect the USB port of the digital drum to a USB port of your computer using a single USB A-B cable.
2. Setup the active track of your sequencer on Channel 10. Activate RECORD on your sequencer.
3. Play the pads of your digital drum.
4. Stop recording. Locate your sequencer to the start of your recording.
5. Playback the recorded sequencer.

Making the Settings for MIDI

Using the Digital Drum as a Sound Module

Connecting an external keyboard or sequencer to the MIDI Input allows you to use the digital drum as a multi-part, polyphonic sound module to play various instrument parts in addition to your drums (for instance, Piano on Channel 1, Bass on Channel 2, Strings on Channel 3, etc). The voices on each MIDI channel are selected using MIDI Program Change messages (refer to **GM Backing Instrument List**).

The MIDI system in the digital drum has 16 reception channels numbered from 1-16. Each of the channels is responsible for a voice. When the instrument receives MIDI information from an external device, the active channel is determined by the control message. Channel 10 is reserved for Drums. The digital drum has two options for Channel 10: GM ON or OFF, as selected in UTILITY MIDI menu.

When GM Mode is ON, Channel 10 will play the GM percussion kits.

When GM Mode is OFF, Channel 10 will play the digital drum internal kits.

Note:

For more information on received MIDI messages, refer to **MIDI implementation chart**.

Troubleshooting

	Possible Cause and Solution
No Sound	1) Rotate the [VOLUME] knob to be sure that the volume isn't down. 2) To be sure that Local Mode should be set to "ON".
No Sound from Pads	1) To be sure that the pad is connected correctly. 2) To be sure not set the volume of the pad to 0.
No Click Sound	1) To be sure not set the volume of the click to 0.
Sound is Distorted	1) Turn down the volume.



Specification

Polyphony

64

Drum Voices

Drum Voices: 678 (Drums, Percussion, SFX...) and 18 Hi-Hat Combinations

General MIDI Backing Voices: 128 GM Instruments

Drum Kits

99 (40 Preset Kits + 59 User Kits)

Mixer

Kit volume / Song Volume / SD Card MIDI Song Volume / Click Volume

Effect Type

Reverb

4-Band Master EQ

Sequencer

Preset song: 120

User song: 100

Song Parts: 7 (Drum, Percussion, Part 1-Part 5)

Play Modes: 1 Shot/ Loop/Tap/Hit

Tempo: 30-280

Resolution: 192 ticks per quarter note

Tempo

30~280

Part Mute Function

Click

Click Voice/ Time signature / Interval / Volume

MIDI function

MIDI IN / MIDI OUT/MIDI THRU (soft), USB MIDI

SD Card

Save/Load Kits, Songs and User Settings

Play Standard MIDI Files (up to 16 channels)

Hardware

Sturdy 4-Legged Drum Rack with All Mounting Hardware

8" Dual-Zone Tom Mesh Pad x 3

10" Dual-Zone Tom4 Mesh Pad

10" Dual-Zone Snare Mesh Pad

8" Kick Mesh Pad

12" Dual-Zone Crash Pads with Choke x 2

12" Dual-Zone Hi-Hat Pad with Choke

14" Triple-Zone Ride Pad with Bell and Choke

Hi-Hat Controller Pedal

IO Port

Phone, MIDI IN/OUT, USB MIDI, AUX IN/OUT

Power Supply

DC 9V

Dimensions (sound module)

300(W) × 330(H) × 160(D)mm

Weight (sound module)

915g

* All specifications and appearances are subject to change without notice.

Drum Kit List

NO.	Full Name	LCD Display
1	Acoustic 1	Acoust-1
2	Funk Band	FunkBand
3	Power	Pwrbd
4	Standard 1	Std-2
5	Acoustic 2	Acoust-2
6	Fusion	Fusion
7	Camco	Camco
8	Jazz Brush	JzBrush
9	Room	Room
10	Rock	Rock
11	Pop Rock	PopRock
12	Jazz	Jazz
13	Brush	Brush
14	Songo	Songo
15	1971's	1971's
16	Tablas	Tablas
17	Old School	O school
18	606	606
19	Disco	Disco
20	909	909

NO.	Full Name	LCD Display
21	Drum & Bass	DrumBass
22	Funk	Funk
23	HipHop 1	HipHop-1
24	HipHop 2	HipHop-2
25	House 1	House-1
26	House 2	House-2
27	Vintage	Vintage
28	Junkyard	Junkyard
29	M-box	M-box
30	Step	Step
31	Industry	Industry
32	Low Fi	Lowfi
33	Metal	Metal
34	Electronic	Electron
35	Jazz Latin	JzLatin
36	Noise	Noise
37	Standard 2	Std-1
38	R&B	R&B
39	Magic	Magic
40	Teckno	Teckno

Drum Voice List

NO	Full Name	LCD Display
KICK		
1	Standard Kick 1	StandK1
2	Standard Kick 2	StandK2
3	Classic Kick 1	ClassK1
4	Classic Kick 2	ClassK2
5	Rock Kick 1	RockK1
6	Rock Kick 2	RockK2
7	Rock Kick 3	RockK3
8	Room Kick 1	RoomK1
9	Room Kick 2	RoomK2
10	Jazz Kick 1	JazzK1
11	Jazz Kick 2	JazzK2
12	Big Band Kick 1	BigBdK1
13	Big Band Kick 2	BigBdK2
14	Camco Kick 1	CamcoK1
15	Camco Kick 2	CamcoK2
16	Funk Kick 1	FunkK1
17	Funk Kick 2	FunkK2
18	Funk Kick 3	FunkK3
19	HipHop Kick 1	HipHopK1
20	HipHop Kick 2	HipHopK2
21	HipHop Kick 3	HipHopK3
22	HipHop Kick 4	HipHopK4
23	1969 Kick	1969K
24	1971 Kick	1971K
25	1976 Kick	1976K
26	Power Kick	PowerK
27	R&B Kick	R&BK
28	Voice Kick	VoiceK
29	Acoustic Kick 1	AcousK1
30	Acoustic Kick 2	AcousK2
31	Acoustic Kick 3	AcousK3
32	Acoustic Kick 4	AcousK4
33	Acoustic Kick 5	AcousK5
34	Acoustic Kick 6	AcousK6
35	Acoustic Kick 7	AcousK7
36	Acoustic Kick 8	AcousK8
37	Acoustic Kick 9	AcousK9
38	Acoustic Kick 10	AcousK10
39	Acoustic Kick 11	AcousK11
40	Acoustic Kick 12	AcousK12
41	Acoustic Kick 13	AcousK13
42	Acoustic Kick 14	AcousK14
43	Acoustic Kick 15	AcousK15
44	Acoustic Kick 16	AcousK16
45	Acoustic Kick 17	AcousK17
46	Acoustic Kick 18	AcousK18
47	Acoustic Kick 19	AcousK19
48	Acoustic Kick 20	AcousK20
49	Acoustic Kick 21	AcousK21
50	Acoustic Kick 22	AcousK22
51	Acoustic Kick 23	AcousK23
52	Acoustic Kick 24	AcousK24
53	Acoustic Kick 25	AcousK25
54	Acoustic Kick 26	AcousK26
55	House Kick 1	HouseK1
56	House Kick 2	HouseK2
57	House Kick 3	HouseK3
58	House Kick 4	HouseK4
59	Step Kick	StepK
60	Teckno Kick	TechnoK
61	Drum & Bass Kick	D&BK
62	Junkyard Kick	JunkydK
63	Noise Kick	NoiseK
64	Industry Kick	IndustrK
65	Low Fi Kick	LowFiK
66	Disco Kick	DiscoK
67	808 Kick	808K

68	909 Kick	909K
69	Electronic Kick 1	ElectK1
70	Electronic Kick 2	ElectK2
71	Electronic Kick 3	ElectK3
72	Electronic Kick 4	ElectK4
73	Electronic Kick 5	ElectK5
74	Electronic Kick 6	ElectK6
75	Electronic Kick 7	ElectK7
76	Electronic Kick 8	ElectK8
77	Electronic Kick 9	ElectK9
78	Electronic Kick 10	ElectK10
79	Electronic Kick 11	ElectK11
80	Electronic Kick 12	ElectK12
81	Electronic Kick 13	ElectK13
82	Electronic Kick 14	ElectK14
83	Electronic Kick 15	ElectK15
84	Electronic Kick 16	ElectK16
85	Electronic Kick 17	ElectK17
86	Electronic Kick 18	ElectK18
SNARE		
87	Classic Snare 1	ClasSn1
88	Classic Snare Rim 1	ClasSnR1
89	Classic Snare 2	ClasSn2
90	Classic Snare Rim 2	ClasSnR2
91	Classic Snare 3	ClasSn3
92	Classic Snare Rim 3	ClasSnR3
93	Classic Snare 4	ClasSn4
94	Classic Snare Rim 4	ClasSnR4
95	Acoustic Snare	AcoutSn
96	Acoustic Snare Rim	AcoutSnR
97	Standard Snare 1	StdSn1
98	Standard Snare Rim 1	StdSnR1
99	Standard Snare 2	StdSn2
100	Standard Snare Rim 2	StdSnR2
101	Standard Snare 3	StdSn3
102	Rock Snare 1	RockSn1
103	Rock Snare Rim 1	RockSnR1
104	Rock Snare 2	RockSn2
105	Rock Snare 3	RockSn3
106	Room Snare 1	RoomSn1
107	Room Snare 2	RoomSn2
108	Room Snare 3	RoomSn3
109	Jazz Snare 1	JazzSn1
110	Jazz Snare Rim 1	JazzSnR1
111	Jazz Snare 2	JazzSn2
112	Jazz Snare Rim 2	JazzSnR2
113	Jazz Latin Snare	JzLtiSn
114	Big Band Snare	BigBdSn
115	Camco Snare	CamoSn
116	Camco Snare Rim	CamoSnR
117	Brush Snare 1	BrushSn1
118	Brush Snare 2	BrushSn2
119	Brush Snare Rim	BrushSnR
120	Funk Snare 1	FunkSn
121	Funk Stick	FunkSt
122	Funk Band Snare Stick	FuBdSnSt
123	Funk Band Snare	FuBdSn
124	Funk Band Snare Rim	FuBdSnR
125	Fusion Snare	FusionSn
126	Fusion Snare Stick	FusnSnSt
127	Snare Stick	SnareSt
128	Power Snare	PowerSn
129	Ringo Snare	RingoSn
130	Ringo Snare Rim	RingoSnR
131	HipHop Snare 1	HipHpSn1
132	HipHop Snare 2	HipHpSn2
133	506 Snare 1	506Sn1
134	506 Snare Rim 1	506SnR1
135	506 Snare 2	506Sn2

136	506 Snare Rim 2	506SnR2
137	1969 Snare	1969Sn
138	1969 Snare Rim	1969SnR
139	1971 Snare	1971Sn
140	1971 Snare Rim	1971SnR
141	1976 Snare	1976Sn
142	1976 Snare Rim	1976SnR
143	R&B Snare	R&BSn
144	R&B Snare Stick	R&BSnSt
145	Low Fi Snare	LowFiSn
146	Low Fi Snare Stick	LoFiSnSt
147	Voice Snare	VoiceSn
148	Voice Snare Rim	VoiceSnR
149	Acoustic Snare 1	AcoutSn1
150	Acoustic Snare 2	AcoutSn2
151	Acoustic Snare 3	AcoutSn3
152	Acoustic Snare 4	AcoutSn4
153	Acoustic Snare 5	AcoutSn5
154	Acoustic Snare 6	AcoutSn6
155	Acoustic Snare 7	AcoutSn7
156	House Snare 1	HouseSn1
157	House Snare 2	HouseSn2
158	House Snare 3	HouseSn3
159	Step Snare	StepSn
160	Step Snare Stick	StepSnSt
161	Teckno Snare 1	TechSn1
162	Teckno Snare 2	TechSn2
163	808 Snare	808Sn
164	909 Snare	909Sn
165	Industry Snare	IndustSn
166	Industry Snare Stick	InduSnSt
167	Drum & Bass Snare 1	D&BSn1
168	Drum & Bass Snare 2	D&BSn2
169	Junkyard Snare	JukySn
170	Junkyard Snare Stick	JukySnSt
171	Noise Snare	NoiseSn
172	606 Snare	606Sn
173	Electronic Snare 1	ElecSn1
174	Electronic Snare 2	ElecSn2
175	Electronic Snare 3	ElecSn3
176	Electronic Snare 4	ElecSn4
177	Electronic Snare 5	ElecSn5
178	Electronic Snare 6	ElecSn6
179	Electronic Snare 7	ElecSn7
180	Electronic Snare 8	ElecSn8
181	Electronic Snare 9	ElecSn9
182	Electronic Snare 10	ElecSn10
183	Electronic Snare 11	ElecSn11
184	Electronic Snare 12	ElecSn12
185	Electronic Snare 13	ElecSn13
186	Electronic Snare 14	ElecSn14
187	Electronic Snare 15	ElecSn15
188	Electronic Snare 16	ElecSn16
189	Electronic Snare 17	ElecSn17
190	Electronic Snare 18	ElecSn18
191	Electronic Snare 19	ElecSn19
192	Electronic Snare 20	ElecSn20
193	Electronic Snare 21	ElecSn21
194	Electronic Snare 22	ElecSn22
195	Electronic Snare 23	ElecSn23
196	Electronic Snare 24	ElecSn24
197	Electronic Snare 25	ElecSn25
198	Electronic Snare 26	ElecSn26
199	Electronic Snare 27	ElecSn27
200	Electronic Snare 28	ElecSn28
201	Electronic Snare 29	ElecSn29
202	Electronic Snare 30	ElecSn30
203	Electronic Snare 31	ElecSn31
204	Electronic Snare 32	ElecSn32

Drum Voice List

205	Electronic Snare 33	ElecSn33
TOM		
206	Classic 1 Tom 1	Cls1Tm1
207	Classic 1 Tom Rim 1	Cls1TmR1
208	Classic 1 Tom 2	Cls1Tm2
209	Classic 1 Tom Rim 2	Cls1TmR2
210	Classic 1 Tom 3	Cls1Tm3
211	Classic 1 Tom Rim 3	Cls1TmR3
212	Classic 1 Tom 4	Cls1Tm4
213	Classic 1 Tom Rim 4	Cls1TmR4
214	Classic 1 Tom 5	Cls1Tm5
215	Classic 1 Tom Rim 5	Cls1TmR5
216	Classic 1 Tom 6	Cls1Tm6
217	Classic 1 Tom Rim 6	Cls1TmR6
218	Classic 2 Tom 1	Cls2Tm1
219	Classic 2 Tom Rim 1	Cls2TmR1
220	Classic 2 Tom 2	Cls2Tm2
221	Classic 2 Tom Rim 2	Cls2TmR2
222	Classic 2 Tom 3	Cls2Tm3
223	Classic 2 Tom Rim 3	Cls2TmR3
224	Classic 2 Tom 4	Cls2Tm4
225	Classic 2 Tom Rim 4	Cls2TmR4
226	Classic 2 Tom 5	Cls2Tm5
227	Classic 2 Tom Rim 5	Cls2TmR5
228	Classic 2 Tom 6	Cls2Tm6
229	Classic 2 Tom Rim 6	Cls2TmR6
230	Camco Tom 1	CamcoTm1
231	Camco Tom 2	CamcoTm2
232	Camco Tom 3	CamcoTm3
233	Camco Tom 4	CamcoTm4
234	Camco Tom 5	CamcoTm5
235	Camco Tom 6	CamcoTm6
236	Acoustic Tom 1	AcouTm1
237	Acoustic Tom Rim 1	AcouTmR1
238	Acoustic Tom 2	AcouTm2
239	Acoustic Tom Rim 2	AcouTmR2
240	Acoustic Tom 3	AcouTm3
241	Acoustic Tom Rim 3	AcouTmR3
242	Acoustic Tom 4	AcouTm4
243	Acoustic Tom Rim 4	AcouTmR4
244	Acoustic Tom 5	AcouTm5
245	Acoustic Tom Rim 5	AcouTmR5
246	Acoustic Tom 6	AcouTm6
247	Acoustic Tom Rim 6	AcouTmR6
248	Standard Tom 1	StandTm1
249	Standard Tom 2	StandTm2
250	Standard Tom 3	StandTm3
251	Standard Tom 4	StandTm4
252	Standard Tom 5	StandTm5
253	Standard Tom 6	StandTm6
254	Rock Tom 1	RockTm1
255	Rock Tom 2	RockTm2
256	Rock Tom 3	RockTm3
257	Rock Tom 4	RockTm4
258	Rock Tom 5	RockTm5
259	Rock Tom 6	RockTm6
260	Room Tom 1	RoomTm1
261	Room Tom 2	RoomTm2
262	Room Tom 3	RoomTm3
263	Room Tom 4	RoomTm4
264	Room Tom 5	RoomTm5
265	Room Tom 6	RoomTm6
266	Timpani	Timpani
267	Funk Tom 1	FunkTm1
268	Funk Tom 2	FunkTm2
269	Funk Tom 3	FunkTm3
270	Fusion Tom 1	FusnTm1
271	Fusion Tom 2	FusnTm2
272	Fusion Tom 3	FusnTm3

273	1969 Tom 1	1969Tm1
274	1969 Tom 2	1969Tm2
275	1969 Tom 3	1969Tm3
276	1971 Tom 1	1971Tm1
277	1971 Tom 2	1971Tm2
278	1971 Tom 3	1971Tm3
279	1976 Tom 1	1976Tm1
280	1976 Tom 2	1976Tm2
281	1976 Tom 3	1976Tm3
282	HipHop Tom 1	HipHpTm1
283	HipHop Tom 2	HipHpTm2
284	HipHop Tom 3	HipHpTm3
285	HipHop Tom 4	HipHpTm4
286	HipHop Tom 5	HipHpTm5
287	HipHop Tom 6	HipHpTm6
288	Jazz 1 Tom 1	Jazz1Tm1
289	Jazz 1 Tom 2	Jazz1Tm2
290	Jazz 1 Tom 3	Jazz1Tm3
291	Jazz 2 Tom 1	Jazz2Tm1
292	Jazz 2 Tom 2	Jazz2Tm2
293	Jazz 2 Tom 3	Jazz2Tm3
294	Jazz 2 Tom 4	Jazz2Tm4
295	Jazz 2 Tom 5	Jazz2Tm5
296	Jazz 2 Tom 6	Jazz2Tm6
297	Brush 1 Tom 1	Bsh1Tm1
298	Brush 1 Tom 2	Bsh1Tm2
299	Brush 1 Tom 3	Bsh1Tm3
300	Brush 1 Tom 4	Bsh1Tm4
301	Brush 1 Tom 5	Bsh1Tm5
302	Brush 1 Tom 6	Bsh1Tm6
303	Brush 2 Tom 1	Bsh2Tm1
304	Brush 2 Tom Rim 1	Bsh2TmR1
305	Brush 2 Tom 2	Bsh2Tm2
306	Brush 2 Tom Rim 2	Bsh2TmR2
307	Brush 2 Tom 3	Bsh2Tm3
308	Brush 2 Tom Rim 3	Bsh2TmR3
309	Brush 2 Tom 4	Bsh2Tm4
310	Brush 2 Tom Rim 4	Bsh2TmR4
311	Brush 2 Tom 5	Bsh2Tm5
312	Brush 2 Tom Rim 5	Bsh2TmR5
313	Brush 2 Tom 6	Bsh2Tm6
314	Brush 2 Tom Rim 6	Bsh2TmR6
315	Tom Rim	TomRim
316	606 Tom 1	606Tm1
317	606 Tom 2	606Tm2
318	606 Tom 3	606Tm3
319	606 Tom 4	606Tm4
320	606 Tom 5	606Tm5
321	606 Tom 6	606Tm6
322	808 Tom 1	808Tm1
323	808 Tom 2	808Tm2
324	808 Tom 3	808Tm3
325	808 Tom 4	808Tm4
326	808 Tom 5	808Tm5
327	808 Tom 6	808Tm6
328	Electronic Tom 1	ElectTm1
329	Electronic Tom 2	ElectTm2
330	Electronic Tom 3	ElectTm3
331	Electronic Tom 4	ElectTm4
332	Electronic Tom 5	ElectTm5
333	Electronic Tom 6	ElectTm6
334	Step Tom 1	StepTm1
335	Step Tom 2	StepTm2
336	Step Tom 3	StepTm3
337	909 Tom 1	909Tm1
338	909 Tom 2	909Tm2
339	909 Tom 3	909Tm3
340	Junkyard Tom 1	JunkyTm1
341	Junkyard Tom 2	JunkyTm2

342	Junkyard Tom 3	JunkyTm3
343	Noise Tom 1	NoiseTm1
344	Noise Tom 2	NoiseTm2
345	Noise Tom 3	NoiseTm3
346	Voice Tom 1	VoiceTm1
347	Voice Tom 2	VoiceTm2
348	Voice Tom 3	VoiceTm3
349	Industry Tom 1	InduTm1
350	Industry Tom 2	InduTm2
351	Industry Tom 3	InduTm3
RIDE		
352	Standard 20" Ride	Std20Rd
353	Standard 22" Ride	Std22Rd
354	Standard Ride Bell	StdRdBell
355	Rock Ride	RockRd
356	Rock Bell	RockBell
357	Dry Ride Bell	DryRdBell
358	Vintage Ride	VintgRd
359	60's Ride	60'sRd
360	Clean Pop Ride	ClnPopRd
361	Clean Pop Ride Bell	PopRdBell
362	Light Flat Ride	LigtFIRd
363	Flat Ride	FlatRd
364	Teckno Ride 1	TechRd1
365	Teckno Ride 2	TechRd2
366	Junkyard Break	JyBreak
367	Junkyard Metal	JyMetal
368	Classic Ride	ClasRd
369	Classic Ride Bell	ClasRdBell
370	Acoustic Ride	AcouRd
371	Acoustic Ride Bell	AcouRdBell
372	Jazz Ride	JazzRd
373	Jazz Ride Bell	JazzRdBell
374	Brush Ride	BrshRd
375	Brush Ride Bell	BrshRdBell
376	Mute Ride Bell	MuteRdBell
377	Ride Edge 1	RideEg1
378	Ride Edge 2	RideEg2
379	60's Ride Rim	60'sRdR
380	Clean Pop Ride Rim	ClnPopRdR
381	Sky Ride Rim	SkyRdR
CRASH		
382	Classic Crash Bell 1	ClcCrB11
383	Classic Crash Bell 2	ClcCrB12
384	Standard Crash 1	StdCr1
385	Class China	ClcChina
386	Standard Crash 2	StdCr2
387	Standard Crash Bell 1	StdCrB11
388	Standard Crash Bell 2	StdCrB12
389	China 1	China1
390	Classic Crash 1	ClassCr1
391	Classic Crash 2	ClassCr2
392	Classic Crash 3	ClassCr3
393	Classic Crash 4	ClassCr4
394	Splash	Splash
395	Splash Bell	SplashBell
396	Rock Crash	RockCr
397	Rock Splash	RkSplash
398	Jazz Splash	JzSplash
399	Jazz Splash Bell	JzSpBell
400	Brush Crash	BrushCr
401	Crystal Crash	CrystlCr
402	Crystal Crash Bell	CryCrBell
403	China 2	China2
404	China Low	ChinaLow
405	Orchestra Hit 1	OrHit1
406	Orchestra Hit 2	OrHit2
407	Orchestra Hit Bell	OrHitBell
408	Drum & Bass Crash 1	D&BCr1

Drum Voice List

409	Drum & Bass Crash 2	D&BCr2
410	China 3	China3
411	606 Cymbal 1	606Cr1
412	606 Cymbal 2	606Cr2
413	808 Cymbal 1	808Cr1
414	808 Cymbal 2	808Cr2
415	909 Cymbal 1	909Cr1
416	909 Cymbal 2	909Cr2
417	Junkyard Cymbal 1	JunkyCr1
418	Junkyard Cymbal 2	JunkyCr2
419	Cymbal Effect 1	EffecCr1
420	Cymbal Effect 2	EffecCr2
421	Laser Ray	LaserRay
422	Drive By	DriveBy
423	Industrial Short	IndShort
424	Industrial Long	IndLong
HIHAT		
425	Standard 1 Hi-hat 1	Std1HH1
426	Standard 1 Hi-hat 2	Std1HH2
427	Standard 2 Hi-hat Open	St2HHOp
428	Standard 2 Hi-hat Open Rim	St2HHOpR
429	Rock Hi-hat Open	RockHHOp
430	Pop Hi-hat Open	PopHHOp
431	Pop Hi-hat Open Rim	PopHHOpR
432	Brush Hi-hat Open	BrshHHOp
433	60's Hi-hat Open	60'sHHOp
434	Mini Hi-hat Open	MinHHOp
435	Mini Hi-hat Open Rim	MinHHOpR
436	Classic Hi-hat Open 1	ClshHHOp1
437	Classic Hi-hat Open 2	ClshHHOp2
438	Camco Hi-hat Open	CamHHOp
439	Voice Hi-hat Open	VoicHHOp
440	House Hi-hat Open	HousHHOp
441	606 Hi-hat Open	606HHOp
442	808 Hi-hat Open	808HHOp
443	909 Hi-hat Open	909HHOp
444	Junkyard Hi-hat Open	JukyHHOp
445	Noise Hi-hat Open	NoisHHOp
446	Bass Hi-hat Open	BassHHOp
447	Standard Hi-hat Half Open	StdHfOp
448	Rock Hi-hat Half Open	RockHfOp
449	Pop Hi-hat Half Open	PopHfOp
450	Pop Hi-hat Half Open Rim	PopHfOpR
451	Brush Hi-hat Half Open	BrshHfOp
452	60's Hi-hat Half Open	60'sHfOp
453	Mini Hi-hat Half Open	MinHfOp
454	Mini Hi-hat Half Open Rim	MinHfOpR
455	Classic Hi-hat Half Open Rim 1	ClshHfOpR1
456	Classic Hi-hat Half Open Rim 2	ClshHfOpR2
457	Camco Hi-hat Half Open	CamHfOp
458	Junkyard Hi-hat Half Open Rim	JyHfOpR
459	Standard Hi-hat Close 1	StdHHCs1
460	Standard Hi-hat Close 2	StdHHCs2
461	Rock Hi-hat Close	RockHHCs
462	Pop Hi-hat Close	PopHHCs
463	Pop Hi-hat Close Rim	PopHHCsR
464	Brush Hi-hat Close	BrshHHCs
465	60's Hi-hat Close	60'sHHCs
466	Mini Hi-hat Close	MinHHCs
467	Mini Hi-hat Close Rim	MinHHCsR
468	Classic Hi-hat Close 1	ClshHHCs1
469	Classic Hi-hat Close 2	ClshHHCs2
470	Classic Hi-hat Close Rim	ClshHHCsR
471	Camco Hi-hat Close	CamHHCs
472	Voice Hi-hat Close	VoicHHCs
473	House Hi-hat Close	HousHHCs
474	606 Hi-hat Close	606HHCs
475	808 Hi-hat Close	808HHCs
476	909 Hi-hat Close	909HHCs

477	Junkyard Hi-hat Close	JukyHHCs
478	Noise Hi-hat Close	NoisHHCs
479	Bass Hi-hat Close	BrshHHCs
480	Standard Hi-hat Pedal 1	StdHHPd1
481	Standard Hi-hat Pedal 2	StdHHPd2
482	Rock Hi-hat Pedal	RockHHPd
483	Pop Hi-hat Pedal	PopHHPd
484	Brush Hi-hat Pedal	BrshHHPd
485	60's Hi-hat Pedal	60'sHHPd
486	Mini Hi-hat Pedal	MiniHHPd
487	Classic Hi-hat Pedal 1	ClshHHPd1
488	Classic Hi-hat Pedal 2	ClshHHPd2
489	Camco Hi-hat Pedal	CamcHHPd
490	Voice Hi-hat Pedal	VoicHHPd
491	House Hi-hat Pedal	HousHHPd
492	606 Hi-hat Pedal	606HHPd
493	808 Hi-hat Pedal	808HHPd
494	Junkyard Hi-hat Pedal	JukyHHPd
495	Noise Hi-hat Pedal	NoisHHPd
496	Bass Hi-hat Pedal	BassHHPd
497	Hi-hat Splash	HHSplash
498	Pop Splash	PopSp
499	Mini Splash	MiniSp
500	Classic Splash 1	ClassSp1
501	Classic Splash 2	ClassSp2
502	Mute	Mute
PERCUSSION		
503	Metronome Bell	MetronBl
504	Metronome Click	MetronCl
505	Scratch	Scratch
506	Scratch Push	ScratchP
507	DJ Electronic FX	DJEFX
508	High Q	HighQ
509	Ding Bell	DingBl
510	Finger Slaps	FingeSlp
511	Standard Clap	StdClap
512	Tambourine	Tambour
513	Vibra-slap	Vibraslps
514	Agogo High	AgogoHi
515	Agogo Low	AgogoLo
516	Bell Tree	BellTree
517	Bongo High	BongoHi
518	Bongo Low	BongoLo
519	Shaker	Shaker
520	Conga Slap High	CgslpHi
521	Conga Slap Low	CgslpLo
522	Electronic Conga Low	ElecCgLo
523	Open Conga	OpCga
524	Conga Slap	Cgaslp
525	Cowbell	Cowbell
526	Timbale High	TimbHi
527	Timbale Low	TimbLo
528	Timpani High	TimpHi
529	Timpani Low	TimpLo
530	Open Tabla High	OpTbHi
531	Open Tabla Low	OpTbLo
532	Tabla Slap	SlpTbI
533	Mute Tabla Slap	MtSlpTbI
534	Cabasa	Cabasa
535	Maracas	Maracas
536	Short Whistle	Whistle
537	Short Guiro	StGuairo
538	Long Guiro	LgGuairo
539	Claves	Claves
540	Wood Block	WoodBl
541	Mute Cuica	MtCuica
542	Open Cuica	OpCuica
543	Mute Triangle	MtTria
544	Open Triangle	OpTria

546	Wind Chimes	WindCh
547	Castanets	Castanet
548	Mute Surdo	MtSurdo
549	Open Surdo	OpSurdo
550	Lotus Drum	LotusDrm
551	Cowbell 1	Cowbel1
552	Cowbell 2	Cowbel2
553	Cowbell 3	Cowbel3
554	Cowbell 4	Cowbel4
555	Cowbell 5	Cowbel5
556	Cowbell 6	Cowbel6
557	Cowbell 7	Cowbel7
558	Cowbell 8	Cowbel8
559	Cowbell 9	Cowbel9
560	Cowbell 10	Cowbel10
561	Cowbell 11	Cowbel11
562	Tabla 1	Tabla1
563	Tabla 2	Tabla2
564	Tabla 3	Tabla3
565	Tabla 4	Tabla4
566	Tabla 5	Tabla5
567	Tabla 6	Tabla6
SFX		
568	FX 1	FX1
569	FX 2	FX2
570	FX 3	FX3
571	FX 4	FX4
572	FX 5	FX5
573	FX 6	FX6
574	FX 7	FX7
575	FX 8	FX8
576	FX 9	FX9
577	FX 10	FX10
578	FX 11	FX11
579	FX 12	FX12
580	FX 13	FX13
581	FX 14	FX14
582	FX 15	FX15
583	FX 16	FX16
584	FX 17	FX17
585	FX 18	FX18
586	FX 19	FX19
587	FX 20	FX20
588	FX 21	FX21
589	FX 22	FX22
590	FX 23	FX23
591	FX 24	FX24
592	FX 25	FX25
593	FX 26	FX26
594	FX 27	FX27
595	FX 28	FX28
596	FX 29	FX29
597	FX 30	FX30
598	FX 31	FX31
599	FX 32	FX32
600	FX 33	FX33
601	FX 34	FX34
602	FX 35	FX35
603	FX 36	FX36
604	FX 37	FX37
605	FX 38	FX38
606	FX 39	FX39
607	FX 40	FX40
608	FX 41	FX41
609	FX 42	FX42
610	FX 43	FX43
611	FX 44	FX44
612	FX 45	FX45
613	FX 46	FX46

Drum Voice List

614	FX47	FX47
615	FX48	FX48
616	FX49	FX49
617	FX50	FX50
618	FX51	FX51
619	FX52	FX52
620	FX53	FX53
621	FX54	FX54
622	FX55	FX55
623	FX56	FX56
624	FX57	FX57
625	FX58	FX58
626	FX59	FX59
627	FX60	FX60
628	FX61	FX61
629	FX62	FX62
630	FX63	FX63
631	FX64	FX64
632	FX65	FX65
633	FX66	FX66
634	FX67	FX67
635	FX68	FX68
636	FX69	FX69
637	FX70	FX70
638	DJ1	DJ1
639	DJ2	DJ2
640	DJ3	DJ3
641	DJ4	DJ4
642	DJ5	DJ5
643	DJ6	DJ6
644	DJ7	DJ7
645	DJ8	DJ8
646	DJ9	DJ9
647	DJ10	DJ10
648	FX71	FX71
649	FX72	FX72
650	FX73	FX73
651	FX74	FX74
652	FX75	FX75
653	FX76	FX76
654	FX77	FX77
655	FX78	FX78
656	FX79	FX79
657	FX80	FX80
658	FX81	FX81
659	FX82	FX82
660	FX83	FX83
661	FX84	FX84
662	FX85	FX85
663	FX86	FX86
664	FX87	FX87
665	One	One
666	Two	Two
667	Three	Three
668	Four	Four
669	Five	Five
670	Six	Six
671	Seven	Seven
672	Eight	Eight
673	Nine	Nine
674	Ti	Ti
675	Ta	Ta
676	Ei	Ei
677	An	An
678	E	E

HIHAT COMBINATION		
679	Standard 1	Standrd1
680	Standard 2	Standrd2
681	Rock	Rock
682	Pop	Pop
683	Brush	Brush
684	Vintage	Vintage
685	Mini	Mini
686	Classic 1	Classic1
687	Classic 2	Classic2
688	Jazz	Jazz
689	Voice	Voice
690	House	House
691	606	606
692	808	808
693	909	909
694	Junk	Junk
695	Dirty	Dirty
696	Bass	Bass



100
95
75
25
5
0

Song List

No.	LCD Name	Name						
	Drum Loop		43	Funk4	Funk 4	86	Disco2	Disco 2
			44	Mambo	Mambo	87	Boogie2	Boogie 2
1	Fusion1	Fusion 1	45	LtinDan2	Latin Dance 2	88	Metal2	Metal 2
2	HipHop	HipHop	46	D&B2	Drum & Bass 2	89	HardRock	Hard Rock
3	16BtPop	16Beat Pop	47	PopRock	Pop Rock	90	Latin1	Latin 1
4	Dance1	Dance 1	48	Punk	Punk	Percussion Loop		
5	LtinDan1	Latin Dance	49	Fusion4	Fusion 4	91	World2	World 2
6	Rock1	Rock 1	50	BreakBt2	Break Beat 2	92	Latin2	Latin 2
7	LatinJz1	Latin Jazz 1	51	DanceRk	Dance Rock	93	Bossa	Bossa
8	Funk1	Funk 1	52	Funk5	Funk 5	94	Samba2	Samba 2
9	LtinPop1	Latin Pop 1	53	Fusion5	Fusion 5	95	3/4Pop	3/4 Pop
10	60'sRock	60's Rock	54	Reggae2	Reggae 2	96	Pop3	Pop 3
11	BigBand1	Big Band 1	55	CoutyBlu	Country Blues	97	Jazz2	Jazz 2
12	D&B1	Drum & Bass 1	56	Pop2	Pop 2	98	Reggae4	Reggae 4
13	Ballad1	Ballad 1	57	Dance2	Dance 2	99	Reggae5	Reggae 5
14	Swing1	Swing 1	58	R&B2	R&B 2	100	LatinRk2	Latin Rock 2
15	Pop1	Pop 1	59	R N'R1	Rock N'Roll 1	HIT		
16	Funk2	Funk 2	60	Boogie1	Boogie 1	101	Fifths	Fifths Tap
17	LatinJz2	Latin Jazz 2	61	Beguine	Beguine	102	SynStr	Synth String Tap
18	PopFunk1	Pop Funk 1	62	Newage	Newage	103	BrighTp1	Brightness Tap 1
19	LatinRk1	Latin Rock 1	63	16Beat	16 Beat	104	Atmosphe	Atmosphere
20	BigBand2	Big Band 2	64	Metal1	Metal 1	105	ChoruTp1	Choru Piano Tap1
21	PopBalld	Pop Ballad	65	6/8Bald2	6/8 Ballad 2	TAP		
22	PopFunk2	Pop Funk 2	66	Dance3	Dance 3	106	BassTp1	Bass Tap 1
23	3/4Jazz	3/4 Jazz	67	8Beat	8 Beat	107	ChoruTp2	Choru Piano Tap2
24	PopBossa	Pop Bossa	68	Blues2	Blues 2	108	BrighTp2	Brightenss Tap 2
25	Samba1	Samba 1	69	Disco1	Disco 1	109	BassTp2	Bass Tap 2
26	6/8Bald1	6/8 Ballad 1	70	Arabic1	Arabic 1	110	PadTap1	Pad Tap 1
27	Fusion2	Fusion 2	71	House	House	111	Vibrapho	Vibraphone
28	Jazz1	Jazz 1	72	Arabic2	Arabic 2	112	BassTp3	Bass Tap 3
29	GtrBossa	Guitar Bossa	73	R N'R2	Rock N'Roll 2	113	RainTap	Rain Tap
30	BreakBt1	Break Beat 1	74	PianoBt	Piano 8 Beat	114	PizzStr	Pizzcato Strings
31	World1	World 1	75	Rock2	Rock 2	115	BassTp4	Bass Tap 4
32	Funk3	Funk 3	1 Shot			116	Crystal	Crystal
33	LatinJz3	Latin Jazz 3	76	LatinJz4	Latin Jazz 4	117	Xylophon	Xylophone
34	LtinPop2	Latin Pop 2	77	Country	Country	118	BassTp5	Bass Tap 5
35	Reggae1	Reggae1	78	BigBand3	Big Band 3	119	PadTap2	Pad Tap 2
36	Fusion3	Fusion 3	79	SlowFus	Slow Fusion	120	GlockTp	Glockenspiel Tap
37	Swing2	Swing 2	80	ModenJz	Modern Jazz			
38	PopShufl	Pop Shuffle	81	D&B3	Drum & Bass 3			
39	Ballad2	Ballad 2	82	Reggae3	Reggae 3			
40	PianoRk	Piano Rock	83	Funk6	Funk 6			
41	Blues1	Blues 1	84	Funk7	Funk 7			
42	R&B1	R&B 1	85	Swing3	Swing 3			

Demo List

Demo No.	Name
1	FUSION
2	WORLD

ASCII Character List

!	#	\$	%	&	'	()	{	}
_	-	,	~	@	0	1	2	3	4
5	6	7	8	9	A	B	C	D	E
F	G	H	I	J	K	L	M	N	O
P	Q	R	S	T	U	V	W	X	Y
Z	a	b	c	d	e	f	g	h	i
j	k	l	m	n	o	p	q	r	s
T	u	v	w	x	y	z			

GM Drum Kit List

Note No.	Standard 1 (bank 0)	Standard 2 (bank 4)	Room (bank 8)	Rock (bank 16)
27-D#1	High Q	<-	<-	<-
28-E1	Slap	<-	<-	<-
29-F1	Scratch Push	<-	<-	<-
30-F#1	Scratch Pull	<-	<-	<-
31-G1	Sticks	<-	<-	<-
32-G#1	Square Click	<-	<-	<-
33-A1	Metronome Click	<-	<-	<-
34-A#1	Metronome Bell	<-	<-	<-
35-B1	Acoustic 1 Bass Drum	Acoustic 2 Bass Drum	Room Bass Drum 1	Rock Bass Drum 1
36-C2	Standard 1 Bass Drum	Standard 2 Bass Drum	Room Bass Drum 2	Rock Bass Drum 2
37-C#2	Side Stick	<-	<-	<-
38-D2	Standard 1 Snare	Standard 2 Snare	Room Snare	Rock Snare
39-D#2	Hand Clap	<-	<-	<-
40-E2	Standard 1 Snare Rim	Standard 2 Snare Rim	Room Snare Rim	Rock Snare Rim
41-F2	Standard 1 Tom 6	Standard 2 Tom 6	Room Tom 6	Rock Tom 6
42-F#2	Standard 1 Hi-hat Close	Standard 2 Hi-hat Close	Room Hi-hat Close	Rock Hi-hat Close
43-G2	Standard 1 Tom 5	Standard 2 Tom 5	Room Tom 5	Rock Tom 5
44-G#2	Standard 1 Hi-hat Pedal	Standard 2 Hi-hat Pedal	Room Hi-hat Pedal	Rock Hi-hat Pedal
45-A2	Standard 1 Tom 4	Standard 2 Tom 4	Room Tom 4	Rock Tom 4
46-A#2	Standard 1 Hi-hat Open	Standard 2 Hi-hat Open	Room Hi-hat Open	Rock Hi-hat Open
47-B2	Standard 1 Tom 3	Standard 2 Tom 3	Room Tom 3	Rock Tom 3
48-C3	Standard 1 Tom 2	Standard 2 Tom 2	Room Tom 2	Rock Tom 2
49-C#3	Standard 1 Crash 1	Standard 2 Crash 1	Room Crash 1	Rock Crash 1
50-D3	Standard 1 Tom 1	Standard 2 Tom 1	Room Tom 1	Rock Tom 1
51-D#3	Standard 1 Ride	Standard 2 Ride	Room Ride	Rock Ride
52-E3	Chinese Cymbal 1	<-	<-	<-
53-F3	Ride Bell	<-	Room Ride Bell	Rock Ride Bell
54-F#3	Tambourine	<-	<-	<-
55-G3	Splash Cymbal	<-	Room Splash Cymbal	Rock Splash Cymbal
56-G#3	Standard 1 Cowbell	Standard 2 Cowbell	Room Cowbell	Rock Cowbell
57-A3	Standard 1 Crash 2	Standard 2 Crash 2	Room Crash 2	Rock Crash 2
58-A#3	Vibra-slap	<-	<-	<-
59-B3	Ride Cymbal	<-	<-	<-
60-C4	Hi Bongo	<-	<-	<-
61-C#4	Low Bongo	<-	<-	<-
62-D4	Mute Hi Conga	<-	<-	<-
63-D#4	Open Hi Conga	<-	<-	<-
64-E4	Low Conga	<-	<-	<-
65-F4	High Timbale	<-	<-	<-
66-F#4	Low Timbale	<-	<-	<-
67-G4	High Agogo	<-	<-	<-
68-G#4	Low Agogo	<-	<-	<-
69-A4	Cabasa	<-	<-	<-
70-A#4	Maracas	<-	<-	<-
71-B4	Short Whistle	<-	<-	<-
72-C5	Long Whistle	<-	<-	<-
73-C#5	Short Guiro	<-	<-	<-
74-D5	Long Guiro	<-	<-	<-
75-D#5	Claves	<-	<-	<-
76-E5	Hi Wood Block	<-	<-	<-
77-F5	Low Wood Block	<-	<-	<-
78-F#5	Mute Cuica	<-	<-	<-
79-G5	Open Cuica	<-	<-	<-
80-G#5	Mute Triangle	<-	<-	<-
81-A5	Open Triangle	<-	<-	<-
82-A#5	Shaker	<-	<-	<-
83-B5	Jingle Bell	<-	<-	<-
84-C6	Bell Tree	<-	<-	<-
85-C#6	Castanets	<-	<-	<-
86-D6	Mute Surdo	<-	<-	<-
87-D#6	Open Surdo	<-	<-	<-

GM Drum Kit List

Note No.	Funk (bank 17)	Electronic (bank 24)	808 (bank 25)	House (bank 28)
27-D#1	<-	<-	<-	<-
28 E1	<-	<-	<-	<-
29-F1	<-	<-	<-	<-
30-F#1	<-	<-	<-	<-
31-G1	<-	<-	<-	<-
32-G#1	<-	<-	<-	<-
33-A1	<-	<-	<-	<-
34-A#1	<-	<-	<-	<-
35-B1	Funk Bass Drum 1	Electronic Bass Drum 1	808 Bass Drum 1	House Bass Drum 1
36-C2	Funk Bass Drum 2	Electronic Bass Drum 2	808 Bass Drum 2	House Bass Drum 2
37-C#2	<-	<-	<-	<-
38-D2	Funk Snare	Electronic Snare	808 Snare	House Snare
39-D#2	<-	<-	<-	House Hand Clap
40-E2	Funk Snare Rim	Electronic Snare Rim	808 Snare Rim	House Snare Rim
41-F2	Funk Tom 6	Electronic Tom 6	808 Tom 6	House Tom 6
42-F#2	Funk Hi-hat Close	Electronic Hi-hat Close	808 Hi-hat Close	House Hi-hat Close
43-G2	Funk Tom 5	Electronic Tom 5	808 Tom 5	House Tom 5
44-G#2	Funk Hi-hat Pedal	Electronic Hi-hat Pedal	808 Hi-hat Pedal	House Hi-hat Pedal
45-A2	Funk Tom 4	Electronic Tom 4	808 Tom 4	House Tom 4
46-A#2	Funk Hi-hat Open	Electronic Hi-hat Open	808 Hi-hat Open	House Hi-hat Open
47-B2	Funk Tom 3	Electronic Tom 3	808 Tom 3	House Tom 3
48-C3	Funk Tom 2	Electronic Tom 2	808 Tom 2	House Tom 2
49-C#3	Funk Crash 1	<-	808 Crash 1	<-
50-D3	Funk Tom 1	Electronic Tom 1	808 Tom 1	House Tom 1
51-D#3	Funk Ride	<-	<-	<-
52-E3	<-	<-	<-	<-
53-F3	<-	<-	<-	<-
54-F#3	<-	<-	<-	<-
55-G3	<-	<-	<-	<-
56-G#3	<-	<-	<-	<-
57-A3	Funk Crash 2	<-	808 Crash 2	<-
58-A#3	<-	<-	<-	<-
59-B3	<-	<-	<-	<-
60-C4	<-	<-	<-	<-
61-C#4	<-	<-	<-	<-
62-D4	<-	<-	808 Mute Hi Conga	<-
63-D#4	<-	<-	808 Open Hi Conga	<-
64-E4	<-	<-	808 Low Conga	<-
65-F4	<-	<-	<-	<-
66-F#4	<-	<-	<-	<-
67-G4	<-	<-	<-	<-
68-G#4	<-	<-	<-	<-
69-A4	<-	<-	<-	<-
70-A#4	<-	<-	808 Maracas	<-
71-B4	<-	<-	<-	<-
72-C5	<-	<-	<-	<-
73-C#5	<-	<-	<-	<-
74-D5	<-	<-	<-	<-
75-D#5	<-	<-	808 Claves	<-
76-E5	<-	<-	<-	<-
77-F5	<-	<-	<-	<-
78-F#5	<-	<-	<-	<-
79-G5	<-	<-	<-	<-
80-G#5	<-	<-	<-	<-
81-A5	<-	<-	<-	<-
82-A#5	<-	<-	<-	<-
83-B5	<-	<-	<-	<-
84-C6	<-	<-	<-	<-
85-C#6	<-	<-	<-	<-
86-D6	<-	<-	<-	<-
87-D#6	<-	<-	<-	<-

GM Drum Kit List

Note No.	Jazz (bank 32)	Brush (bank 40)	Orchestra (bank 48)
27-D#1	<-	<-	Concert Hi-hat Close
28 E1	<-	<-	Concert Hi-hat Pedal
29-F1	<-	<-	Concert Hi-hat Open
30-F#1	<-	<-	Concert Ride
31-G1	<-	<-	<-
32-G#1	<-	<-	<-
33-A1	<-	<-	<-
34-A#1	<-	<-	<-
35-B1	Jazz Bass Drum 1	Brush Bass Drum 1	Concert Bass Drum 1
36-C2	Jazz Bass Drum 2	Brush Bass Drum 2	Concert Bass Drum 2
37-C#2	<-	<-	<-
38-D2	Jazz Snare	Brush Snare	Concert Snare 1
39-D#2	<-	<-	Castanets
40-E2	Jazz Snare Rim	Brush Snare Rim	Concert Snare 2
41-F2	Jazz Tom 6	Brush Tom 6	Timpani F
42-F#2	Jazz Hi-hat Close	<-	Timpani F#
43-G2	Jazz Tom 5	Brush Tom 5	Timpani G
44-G#2	Jazz Hi-hat Pedal	<-	Timpani G#
45-A2	Jazz Tom 4	Brush Tom 4	Timpani A
46-A#2	Jazz Hi-hat Open	<-	Timpani A#
47-B2	Jazz Tom 3	Brush Tom 3	Timpani B
48-C3	Jazz Tom 2	Brush Tom 2	Timpani C
49-C#3	<-	Brush Crash 1	Timpani C#
50-D3	Jazz Tom 1	Brush Tom 1	Timpani D
51-D#3	Jazz Ride	Brush Ride	Timpani D#
52-E3	<-	<-	Timpani E
53-F3	<-	<-	Timpani F
54-F#3	<-	<-	<-
55-G3	<-	<-	<-
56-G#3	<-	<-	<-
57-A3	Chinese Cymbal 2	Brush Crash 2	Concert Crash 1
58-A#3	<-	<-	<-
59-B3	<-	<-	Concert Crash 2
60-C4	<-	<-	<-
61-C#4	<-	<-	<-
62-D4	<-	<-	<-
63-D#4	<-	<-	<-
64-E4	<-	<-	<-
65-F4	<-	<-	<-
66-F#4	<-	<-	<-
67-G4	<-	<-	<-
68-G#4	<-	<-	<-
69-A4	<-	<-	<-
70-A#4	<-	<-	<-
71-B4	<-	<-	<-
72-C5	<-	<-	<-
73-C#5	<-	<-	<-
74-D5	<-	<-	<-
75-D#5	<-	<-	<-
76-E5	<-	<-	<-
77-F5	<-	<-	<-
78-F#5	<-	<-	<-
79-G5	<-	<-	<-
80-G#5	<-	<-	<-
81-A5	<-	<-	<-
82-A#5	<-	<-	<-
83-B5	<-	<-	<-
84-C6	<-	<-	<-
85-C#6	<-	<-	<-
86-D6	<-	<-	<-
87-D#6	<-	<-	<-

100
95
75
25
5
0

GM Backing Instrument List

PIANO		STRINGS		LEAD	
1	Acoustic Grand Piano	41	Violin	81	Lead1 (square)
2	Bright Acoustic Piano	42	Viola	82	Lead2 (sawtooth)
3	Electric Grand Piano	43	Cello	83	Lead3 (calliope)
4	Honky-Tonk Piano	44	Contrabass	84	Lead4 (cliff)
5	E.Piano 1	45	Tremolo Strings	85	Lead5 (charang)
6	E.Piano 2	46	Pizzicato Strings	86	Lead6 (voice)
7	Harpsichord	47	Orchestral Harp	87	Lead7 (fifths)
8	Clavi	48	Timpani	88	Lead8 (bass & lead)
MALLET		STRINGSENSEMBLE		PAD	
9	Celesta	49	Strings Ensemble 1	89	Pad1 (newage)
10	Glockenspiel	50	Strings Ensemble 2	90	Pad2 (warm)
11	Music Box	51	Synth Strings 1	91	Pad3 (polysynth)
12	Vibraphone	52	Synth Strings 2	92	Pad4 (choir)
13	Marimba	53	Choir Aahs	93	Pad5 (bowed)
14	Xylophone	54	Voice Oohs	94	Pad6 (metallic)
15	Tubular Bells	55	Synth Voice	95	Pad7 (halo)
16	Dulcimer	56	Orchestra Hit	96	Pad8 (sweep)
ORGAN		BRASS		EFFECTS	
17	Drawbar Organ	57	Trumpet	97	FX1 (rain)
18	Percussive Organ	58	Trombone	98	FX2 (soundtrack)
19	Rock Organ	59	Tuba	99	FX3 (crystal)
20	Church Organ	60	Muted Trumpet	100	FX4 (atmosphere)
21	Reed Organ	61	French Horn	101	FX5 (brightness)
22	Accordion	62	Brass Section	102	FX6 (goblins)
23	Harmonica	63	Synth Brass 1	103	FX7 (echoes)
24	Tango Accordion	64	Synth Brass 2	104	FX8 (sci-fi)
GUITAR		REED		ETHNIC	
25	Nylon Guitar	65	Soprano Sax	105	Sitar
26	Steel Guitar	66	Alto Sax	106	Banjo
27	Jazz Guitar	67	Tenor Sax	107	Shamisen
28	Clean Guitar	68	Baritone Sax	108	Koto
29	Muted Guitar	69	Oboe	109	Kalimba
30	Overdriven Guitar	70	English Horn	110	Bagpipe
31	Distortion Guitar	71	Bassoon	111	Fiddle
32	Guitar Harmonics	72	Clarinet	112	Shanai
BASS		PIPE		PERCUSSIVE	
33	Acoustic Bass	73	Piccolo	113	Tinkle Bell
34	Finger Bass	74	Flute	114	Agogo
35	Pick Bass	75	Recorder	115	Steel Drums
36	Fretless Bass	76	Pan Flute	116	Wood Block
37	Slap Bass 1	77	Blown Bottle	117	Taiko Drum
38	Slap Bass 2	78	Shakuhachi	118	Melodic Tom
39	Synth Bass 1	79	Whistle	119	Synth Drum
40	Synth Bass 2	80	Ocarina	120	Reverse Cymbal

GM Backing Instrument List

SOUNDEFFECTS	
121	Guitar Fret Noise
122	Breath Noise
123	Seashore
124	Bird Tweet
125	Telephone Ring
126	Helicopter
127	Applause
128	Gunshot



MIDI Implementation Chart

Function	Transmitted	Recognized	Remarks
Basic Default	10ch	1-16ch	
Channel Changed	X	X	
Default	X	X	
Mode Messages	X	X	
Alterde	*****	*****	
Note	0-127	0-127	
Number: True voice	*****	0-127	
Velocity: Note on	○	○	
Note off	○	○	
After key's	○	○(10ch)	
Touch Ch's	X	X	
Pitch Bend	X	○	
Control			
0	X	○	Bank select
1	X	○	Modulation
5	X	○	Portamento time
7	X	○	Volume
10	X	○	Pan
11	X	○	Expression
64	X	○	Sustain Pedal
65	X	○	Portamento on/off
66	X	○	Sostenuto Pedal
67	X	○	Soft Pedal
80	X	○	Reverb Program
81	X	○	Chorus Program
91	X	○	Reverb level
93	X	○	Chorus level
120	X	○	All Sound Off
121	X	○	Reset all controllers
123	X	○	All notes off
Program Change	○	○	
System Exclusive	○	○	GM ON/OFF
System :Song Position	X	X	
Common :Song Select	X	X	
:Tune	X	X	
System : Clock	○	X	
Real Time :Commands	○	X	Start, Stop
Aux : LOCAL ON/OFF	X	X	
: All Notes Off	X	X	
Messages : Active sense	○	X	
: Reset	X	X	

○:YES
X:NO

valid RPN:0,1,2

ddrum[®]

DD518DX_G03

100
95
75
25
5
0